

# COMMERCIAL DRIVER'S GUIDE

to Operation, Safety and Licensing

TRUCKS, BUSES, EMERGENCY RESPONDERS & TAXIS



# A COMMERCIAL DRIVER'S GUIDE

to Operation, Safety  
and Licensing

**TRUCKS, BUSES, EMERGENCY  
RESPONDERS AND TAXIS**

# Introduction

Being a professional driver involves more than just driving a different type of vehicle. It means taking pride in your work and being recognized as a professional driver.

As a professional driver you must always make sure you are mentally and physically fit to drive, your vehicle is well maintained and is in good working condition, and you drive within the law including driving without distractions.

Always drive defensively. Be patient and tolerant of other drivers. Protect yourself, the vehicle, the passengers and the cargo. The more you can anticipate and avoid dangerous situations, the less likely you will be in a collision. Being involved in a collision may result in loss of income, job, health and possibly a life.

Remember that road safety is everyone's business.

This guide is also available on-line.

Web site: [www.transportation.alberta.ca](http://www.transportation.alberta.ca)  
(under Drivers and Vehicles)

## Guides available:

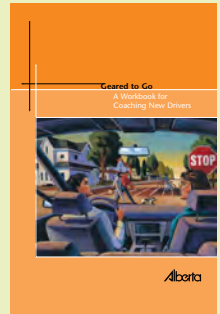
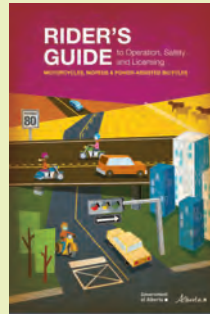
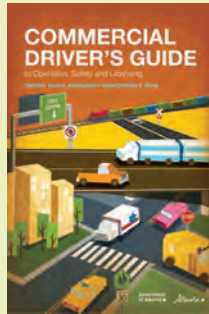
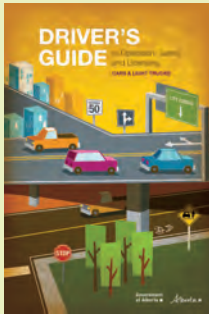

The following guides provide information about the safe operation of cars and light trucks, commercial vehicles, and motorcycles, and the licensing of drivers and riders. These guides provide information for all classes of driver licences in Alberta, and will help you obtain an Alberta driver's licence. Consider keeping the guides in your vehicle as a reference.

### **A DRIVER'S GUIDE TO OPERATION, SAFETY AND LICENSING**

#### **Cars and Light Trucks**

This guide provides information for all drivers.

### **A COMMERCIAL DRIVER'S GUIDE TO OPERATION, SAFETY AND LICENSING**

#### **Trucks, Buses, Emergency Responders and Taxis**

This guide provides information about driving commercial vehicles. It is used with A Driver's Guide to Operation, Safety and Licensing. Both of these guides should be

used when preparing for the knowledge test and when learning to operate a tractor-trailer unit, large truck, ambulance, taxi, bus or school bus, as well as when handling dangerous goods.

### **A RIDER'S GUIDE TO OPERATION, SAFETY AND LICENSING**

#### **Motorcycles, Mopeds and Power-Assisted Bicycles**

This guide provides information on the safe operation of motorcycles, mopeds and power-assisted bicycles. It is used with A Driver's Guide to Operation, Safety and Licensing.

### **GEARED TO GO: A WORKBOOK FOR COACHING NEW DRIVERS**

This guide assists coaches who are providing supervision to new drivers as they gain experience and skills.

This guide, along with the *Driver's Guide to Operation, Safety and Licensing (Cars and Light Trucks)* will give you the necessary information for learning to drive a truck, tractor-trailer, ambulance, taxi or bus.

These two guides provide information that will help you obtain a commercial Alberta driver's licence. It is recommended that you obtain training and education from a licensed driving school to enhance your knowledge and skill. Driver education courses are available for the operation of passenger vehicles, commercial vehicles, and motorcycles.

If you require information about schools that provide driver education, or information about the testing process to obtain an driver's licence:

- refer to your local Yellow Pages
- visit [www.transportation.alberta.ca](http://www.transportation.alberta.ca) (under Drivers and Vehicles)
- contact a Driver Programs Administrator in Edmonton at 780-427-8901 or Calgary at 403-297-6679

You can reach Alberta Government offices toll-free from anywhere in the province by first calling 310-0000.

This guide has no legal authority. Municipalities are given authority under the *Traffic Safety Act* to pass bylaws in areas such as speed zones, school zones, playground zones and parking. You must know local municipal by-laws.

The laws that apply to driving a vehicle can be found in the *Traffic Safety Act* and its related regulations. These documents are available at [www.qp.alberta.ca/Laws\\_Online.cfm](http://www.qp.alberta.ca/Laws_Online.cfm), and:

Queen's Printer Bookstore  
Main Floor, Park Plaza  
10611-98 Avenue  
Edmonton, Alberta T5K 2P7

Tel: 780-427-4952

Fax: 780-452-0668

For toll free service anywhere in Alberta, call 310-0000, then the number.

Some registry agent offices provide knowledge tests and arrange road tests with driver examiners. The driver examiners operate independently and are not employees of the registry.

To find testing services, and information about driver licensing and vehicle registration:

- visit [www.servicealberta.ca/1641.cfm](http://www.servicealberta.ca/1641.cfm)
- visit the Association of Alberta Registries at [www.e-registry.ca](http://www.e-registry.ca)
- refer to your local directory under License and Registry Services
- call 780-427-7013 (Service Alberta)

# Contents

## 1 Commercial Driver's Licence Requirements

- 9 Upgrading your licence
- 10 Knowledge test
- 10 Vision requirements
- 10 Road test
- 12 Learning requirements
- 12 Air brake equipped farm vehicles
- 13 Licences: renewal and changes
- 13 Definitions

## 2 National Safety Code

- 20 Provincial (Alberta) legislation
- 21 Federal legislation
- 22 Vehicle Inspection Program
- 23 Cargo securement

## 3 Trip Inspections

- 26 Purpose of daily vehicle inspections
- 26 Vehicles that require inspections
- 27 Driver inspection required
- 28 Trip inspections

- 35 Trip air brake inspection
- 36 Enroute check stop inspections
- 36 Reporting to a vehicle inspection station
- 37 Post-trip inspection

## 4 Operating Class 1 Vehicles

- 40 Operating a truck-tractor and semi-trailer
- 40 Air brakes
- 41 How long does it take to stop a vehicle?
- 43 Coupling and uncoupling a truck-tractor and semi-trailer
- 45 Coupling mechanisms
- 46 Operating long combination vehicles
- 47 Driving skills and manoeuvres
- 47 Following distance between vehicles
- 48 Off-tracking
- 48 Turns
- 49 Curves
- 50 Parking
- 50 Reversing
- 52 Important information for commercial drivers

## **5** Operating Class 2 Vehicles

- 54 Information for Class 2 and Class 4 bus operators
- 54 Operating a school bus safely
- 54 School bus breakdowns
- 55 Left / Right turns
- 55 Reversing
- 56 Turnarounds
- 56 Passenger loading and unloading
- 58 Parking on a hill
- 58 Railway crossing procedures
- 59 Discipline and problem solving
- 59 Safe driving guidelines

## **6** Operating Class 3 Vehicles

- 62 Loading and unloading dump vehicles
- 64 Mixer truck operators
- 64 Parking on a hill

## **7** Operating Class 4 Vehicles

- 66 Emergency vehicles
- 67 Operating a taxi
- 68 Seat belts
- 68 Reserved lanes
- 69 Other uses for a Class 4 licence

## **8** Transporting Persons with Disabilities

- 72 General rules for communicating
- 72 General rules for driving
- 73 General rules for assisting a person with a wheelchair

## **9** Transporting Dangerous Goods

- 76 Training requirements
- 76 What is a dangerous good?
- 78 Dangerous occurrences
- 78 Documents
- 79 Safety marks

## **10** Responsible Driving Tips for Commercial Drivers

- 82 Distracted Driving Law
- 83 Fatigue
- 84 Railway crossing
- 86 Fire and fire extinguishers

## **11** Fueling and Fuel Efficiency

- 90 Fueling a vehicle: gasoline, diesel, propane
- 90 Fuel efficiency



1

# Commercial Driver's Licence Requirements





Information about the Class 7 and 5 Alberta driver's licence classes, and the vehicles that can be operated in each class, can be found in the *Driver's Guide to Operation, Safety and Licensing (Cars and Light Trucks)* book. All guides are available from any Registry Agent office or on-line at: [www.transportation.alberta.ca](http://www.transportation.alberta.ca) (Under Drivers and Vehicles).

## Class 1

The minimum learning or licensing age is 18 years. You may not apply for a Class 1 driver's licence as a probationary driver.

The holder of a Class 1 driver's licence may operate the following:

- any motor vehicle or combination of vehicles other than a motorcycle
- class 6 type vehicles for learning only

You must provide a tractor-trailer combination with three or more axles, equipped with air brakes for the road test. Proof of your air brake "Q" endorsement or a course completion certificate from an approved air brake organization is required before a road test will be given. This also includes drivers of farm vehicles registered as tractor-trailers.

## Class 2

The minimum learning or licensing age is 18 years. You may not apply for a Class 2 driver's licence as a probationary driver.

The holder of a Class 2 driver's licence may operate the following:

- a bus
- any motor vehicle or combination of vehicles that the holder of a Class 3, 4 or 5 driver's licence may operate
- class 1 and 6 type vehicles for learning only

You must provide a bus with a seating capacity exceeding 24 passengers excluding the operator for a road test. An air brake "Q" endorsement is required to operate air brake equipped vehicles. If the vehicle provided for the road test is equipped with air brakes, you must have either an air brake "Q" endorsement or a course completion certificate from an approved air brake organization.

## Class 3

The minimum learning or licensing age is 18 years. You may not apply for a Class 3 driver's licence as a probationary driver.

The holder of a Class 3 driver's licence may operate the following:

- any motor vehicle or combination of vehicles that the holder of a Class 5 driver's licence may operate
- a single motor vehicle with three or more axles
- a single motor vehicle with three or more axles towing a trailer with one or more axles, if the trailer is not equipped with air brakes
- class 2 or 4 type vehicles without passengers
- all motor vehicles under Classes 1, 2 and 6 for learning only

No holder of a Class 3 driver's licence shall operate a motor vehicle:

- that has a seating capacity of more than 15, while that vehicle is transporting any person other than the driver
- to transport passengers for hire

You must provide a single motor vehicle having three or more axles for the road test. An air brake "Q" endorsement is required to operate air brake equipped vehicles. If the vehicle provided for the road test is equipped with air brakes, you must have either an air brake "Q" endorsement or a course completion certificate from an approved air brake organization.

**NOTE:** Drivers of single-motor vehicles registered as farm vehicles do not require an air brake "Q" endorsement.

## Class 4

The minimum learning or licensing age is 18 years. You may not apply for a Class 4 driver's licence as a probationary driver.

The holder of a Class 4 driver's licence may operate the following:

- any motor vehicle or combination of vehicles that the holder of a Class 5 driver's licence may operate
- a bus that has a seating capacity of not more than 24, excluding the operator
- an ambulance or taxi
- all motor vehicles under classes 1, 2, 3 and 6 for learning only

You must provide a Class 5 vehicle or a bus with a seating capacity not exceeding 24 passengers excluding the operator for a road test. An air brake "Q" endorsement

is required to operate air brake equipped vehicles. If the vehicle provided for the road test is equipped with air brakes, you must have either an air brake "Q" endorsement or a course completion certificate from an approved air brake organization.

## Upgrading your licence

The following information is specific for upgrading an driver's licence to the professional classes.

### General information for Classes 1, 2, 3 and 4

- The minimum learning or licensing age for these classes is 18 years. To learn to drive a commercial class vehicle, you must have at least a Class 5 or a Class 5 GDL driver's licence. You may not apply for these driver's licences if you are in the Graduated Driver Licensing Program.
- You do not need an air brake endorsement when learning to operate a vehicle that is equipped with air brakes.
- A medical report is required to upgrade to a Class 1, 2 or 4 licence.
  - Medical forms are available from a registry agent, or a doctor. A doctor must complete this form.
  - A medical report is required when first applying for a licence and:
    - every 5 years after that, until 45 years of age
    - every 2 years from age 45 to 65
    - every year after you turn age 65.

- You are legally responsible to report any disease or disability that may interfere with the safe operation of a motor vehicle to any Alberta Registry Agent office.
- Alberta Registries can request a medical report from any driver, in any licence class, if they have concerns about a driver's medical condition.
- A fee is charged for each knowledge test, road test, and operator's licence re-classification. For information regarding current fees, contact any Registry Agent office.
- A 10-day waiting period is required for all non-GDL Class 5, 5-6 and 6 new applicants from other Canadian jurisdictions who want to re-class to licence Classes 1 to 4. This waiting period is required for Alberta to confirm the applicant's licence information.
- Driving with the wrong licence class is against the law. It is also an offence for a vehicle's owner to allow the vehicle to be driven by someone who does not have the proper class of licence to drive that vehicle.

## Knowledge test

To upgrade a driver's licence, you will need to pass a knowledge test for the class of licence for which you are applying. You can take your knowledge test at most Alberta Registry Agent offices. The test is based on questions taken from this guide and the *Driver's Guide to Operation, Safety and Licensing (Cars and Light Trucks)* book. You will be asked about safe driving practices, driving laws and road signs. Since Class 1 drivers may operate other

types of vehicles, applicants for a Class 1 licence may be asked questions from the other chapters in this guide.

The test is 30 multiple choice questions and you must score a minimum of 25 correct responses out of 30 to pass. When six questions are answered incorrectly, the test will be stopped and a fail will be recorded.

## Vision requirements

A vision assessment is required before upgrading your Alberta driver's licence. If you do not meet the minimum vision standards, you will be referred to an optometrist or an ophthalmologist to have a Vision Referral form completed. If you have corrective glasses or contact lenses bring them to the vision assessment.

## Road test

If you are applying for a commercial licence in the Class 1, 2 or 3 categories, you will be required to conduct a pre-trip inspection in addition to the road test. You must communicate and demonstrate to the driver examiner:

- a pre-trip inspection of the vehicle
- the appropriate uncouple/couple procedures for Class 1 vehicles
- an inspection of the vehicle's air brake system for units equipped with air brakes.

As part of communicating and demonstrating, you should point to the things you are inspecting and tell the examiner what you are looking at. For example, you could say, "I am checking the left signal light to see that it is working,

is securely mounted, and that the lens is clean and not cracked.”

This guide includes pre-trip inspections for the various types of vehicles. Study and practice the pre-trip that is appropriate for the class of licence you are working towards. The procedures in this book are only guidelines to follow during a road test. A vehicle may require different items to be checked than those listed. You may not refer to any notes during the pre-trip.

Each pre-trip inspection and road test is allowed a certain amount of time. You should be able to complete the inspection and road test within that time.

If a vehicle does not pass the pre-trip inspection, or you do not successfully complete the pre-trip inspection, the road test will not proceed.

An applicant who holds a Graduated Driver Licence (GDL) may not take a road test for a licence classification higher than a Class 5.

**NOTE:** A road test will not be done in a vehicle that is required to display dangerous goods placards.

## Class 1 Road Test

- An applicant must provide a tractor-trailer combination with three or more axles, and the trailer must be equipped with an air brake system to its foundation brakes. You must show proof of your air brake “Q” endorsement or a course completion certificate from an approved air brake organization. This includes drivers of farm vehicles registered as tractor-trailers.
- The examiner must see your road test permit. Permits can be purchased from

most Registry Agents.

- A Class 1 licence may not be obtained without the driver first having qualified for an air brake endorsement. The actual “Q” endorsement does not appear on the Class 1 licence. However, it must appear on all other licence classes that require the operation of air brake equipped vehicles.

## Class 2 Road Test

- An applicant must provide a bus with a seating capacity exceeding 24 passengers, excluding the driver. If the vehicle is equipped with air brakes, the applicant must have either an air brake “Q” endorsement or a course completion certificate from an approved air brake organization.
- The examiner must see your road test permit. Permits can be purchased from most Registry Agents.

## Class 3 Road Test

- An applicant must provide a single motor vehicle that has three or more axles. Three axle recreational vehicles may not be used. If the vehicle provided for the road test is equipped with air brakes, the applicant must have either an air brake “Q” endorsement or a course completion certificate from an approved air brake organization.

**NOTE:** Drivers of single motor vehicles registered as farm vehicles do not require an air brake “Q” endorsement.

- The examiner must see your road test permit. Permits can be purchased from most Registry Agents.

## Class 4 Road Test

**NOTE:** Class 5 vehicles are also suitable for learning.

- An applicant must provide a Class 5 vehicle or a bus with a seating capacity not exceeding 24 passengers, excluding the driver. If the vehicle is equipped with air brakes, the applicant must have either an air brake “Q” endorsement or a course completion certificate from an approved air brake organization.
- The examiner must see your road test permit. Permits can be purchased from most Registry Agents.

## Learning requirements – Classes 1, 2, 3 and 4

Desired Licence Class	Class you must have for Learning	Minimum Licensing Age	Minimum Learning Age	Accompanied by Instructor	Minimum Age of Instructor	Instructor Class must have	Minimum Age to Take Road Test
1	2, 3, 4, 5 or 5-GDL*	18	18	Yes	18	1	18 non-GDL*
2	3, 4, 5 or 5-GDL*	18	18	Yes	18	1 or 2	18 non-GDL*
3	4, 5 or 5-GDL*	18	18	Yes	18	1, 2 or 3	18 non-GDL*
4	3, 5 or 5-GDL*	18	18	Yes	18	1, 2 or 4	18 non-GDL*

\* GDL – Graduated Driver Licence (Probationary)

## Air brake equipped farm vehicles

In Alberta, you are not required to hold an air brake endorsement if operating a single motor vehicle registered as a farm vehicle. However, you do need an air brake endorsement if driving a farm vehicle combination that requires the driver

to hold a Class 1 driver’s licence. When applying for a Class 1 driver’s licence, you will need to show proof of your air brake qualifications, even if the vehicle you will be driving is registered as a farm vehicle.

# Licences: renewal and changes

**It is your responsibility to renew your driver's licence on or before the expiry date.** A licence renewal application will be mailed before the expiry date to your last registered address. You must renew your driver's licence before it expires. If you do not receive your application, you must go to a Registry Agent office.

To change a name or address on your driver's licence, visit any Registry Agent. By law, a person is required to notify Alberta Registries, through a Registry Agent, of any name or address change immediately. Proper identification is required before any change, replacement or renewal can be made.

## Definitions

### Air brakes (air to all foundation brakes)

A vehicle with an air brake system has brakes that are initiated by air pressure from an engine-driven compressor. This sends air pressure through a series of hoses, reservoirs and control valves to all the vehicle's foundation brakes. An air brake "Q" endorsement or Class 1 licence is required to drive a vehicle with an air brake system.

### Air over hydraulic braking system (combination of air and hydraulic foundation brakes)

In an air over hydraulic braking system the vehicle's axles have air actuated foundation

brakes, and some of the vehicle's axles have hydraulic foundation brakes. An air brake "Q" endorsement or Class 1 licence is required to drive this type of vehicle.

### Air actuated hydraulic braking system (air assisted, but all foundation brakes are hydraulic)

In an air actuated hydraulic braking system the air compressor is used to boost the hydraulic system to all the vehicle's foundation brakes. An air brake "Q" endorsement is **NOT** required to drive this type of vehicle.

**NOTE:** No drivers (other than a learner) may operate a vehicle equipped with air brakes, (air to all foundation brakes), unless they hold either a Class 1 driver's licence or a driver's licence with a "Q" (air brake) endorsement.

### Ambulance

An ambulance is an emergency vehicle that is designed to transport injured persons, and is equipped with rescue or first aid equipment.

### Axle

An axle is a shaft on which two or more wheels revolve.

### Bus

Section 130(1) (a) of the Traffic Safety Act; "bus" means a commercial vehicle (i) that is designed for carrying 11 or more persons, including the person driving the vehicle, and

(ii) that is used or intended to be used for the transportation of persons, and includes any other commercial vehicle designated as a bus by regulation;

## “Q” Endorsement

A “Q” endorsement is placed on any class of driver’s licence, except Class 1, when a driver successfully completes an approved Alberta air brake course through an authorized organization. Since it is not possible to get a Class 1 licence without the driver first having qualified for an air brake endorsement, the actual “Q” endorsement will not appear on the Class 1 licence. For information on taking an approved air brake course, please contact a Driver Programs Administrator at:

Edmonton 780-427-8901  
or Calgary 403-297-6679

For toll free service from anywhere in Alberta, call 310-0000.

## “S” Endorsement

Drivers who have a Class 1, 2 or 4 licence can apply for the school bus driver endorsement condition code “S” to be placed on their licence when they successfully complete the School Bus Driver Improvement Program.

**NOTE:** *Effective September 1, 2011 the holder of a Safety Fitness Certificate issued under Alberta’s National Safety Code program shall not allow a person to operate a school bus (school bus as defined under Section 1(1) (k) of the Commercial Vehicle Safety Regulation*

*AR121/2009) that is transporting students to and from school pursuant to Section 19 (1) of the Commercial Vehicle Safety Regulation 121/2009, unless within 12 months of first hiring the driver, the driver has successfully completed the School Bus Driver Improvement course that has been approved by the Registrar. Subsequently, the driver must have the appropriate “S” endorsement on their driver’s licence.*

This condition does not apply to operators of a school bus while conducting school field trips or other trips unrelated to school activities.

## School bus

Section 1(1) (k) of the Commercial Vehicle Safety Regulation;

(k) “school bus” means a bus that meets the requirements of a Type A1, A2, B, C or D school bus described in CSA Standard D250-2007 and that is used primarily to transport students to and from a school;

## Semi-trailer

Means a trailer that:

(i) has axles only at or near its rear end;

(ii) while being towed, is supported at its front end by the truck tractor or the immediately preceding trailer;

(iii) when connected to the truck tractor or preceding trailer, is connected by means of a kingpin and a fifth wheel;



## Trailer

Means a vehicle without motive power that is designed to be towed by another vehicle.

## Truck

Means a motor vehicle designed and intended for the transport of goods or carrying of loads.

## Truck tractor

Means a truck that may be coupled to a semi-trailer by means of a fifth wheel, but does not include a bed truck, picker truck or winch truck.



2

# National Safety Code

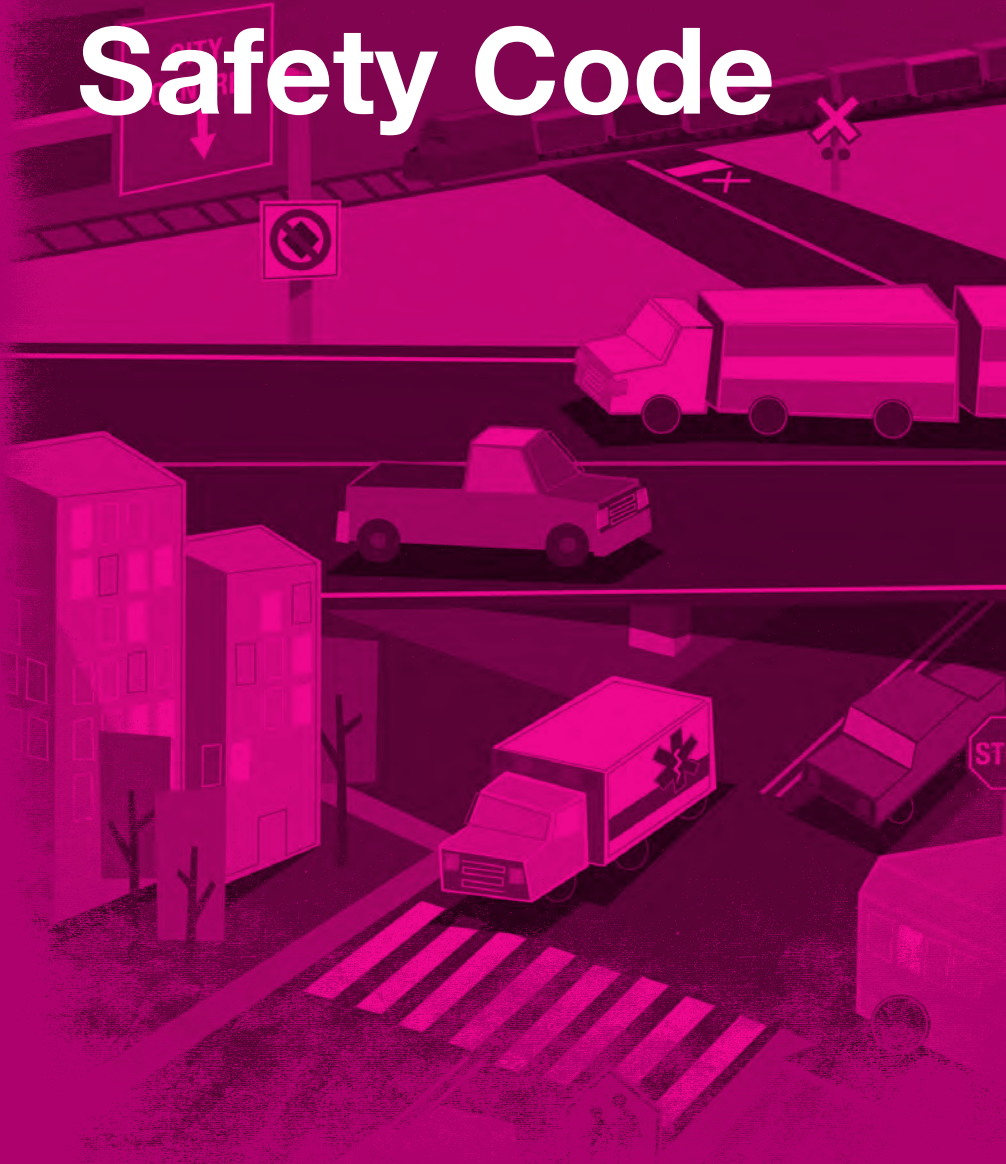

On April 1, 1989 each province and territory in Canada agreed to a set of performance and safety standards for commercial motor carriers and the National Safety Code (NSC) came into effect. Alberta, like the other jurisdictions, has passed legislation to put these standards into effect.

A person or company operating a commercial truck or bus is commonly referred to as a “motor carrier”, or “carrier” for short. There is both provincial and federal NSC legislation that may require a carrier to obtain a Safety Fitness Certificate (SFC). Only one piece of legislation will apply to a carrier at any given time.

Federal law applies to carriers wishing to operate outside of Alberta and requires carriers to obtain an SFC if they operate:

- A truck, tractor, or trailer or any combination of these vehicles registered for or weighing in excess of 4,500 kilograms, or
- A commercial passenger vehicle with an original manufacturer’s seating capacity of 11 or more persons including the driver.

Provincial law applies to carriers operating solely within Alberta and requires carriers to obtain an SFC if they operate:

- A truck, tractor, or trailer or any combination of these vehicles registered for a weight of 11,794 kilograms or greater, or
- A commercial passenger vehicle with an original manufacturer’s seating capacity of 11 or more persons including the driver.

**NOTE:** *Farmers are exempt from the requirement to obtain an SFC under provincial law but NOT the federal regulations.*

Each Canadian jurisdiction regulates carriers that register an NSC vehicle within their jurisdiction. An Alberta SFC can be valid in all other Canadian jurisdictions but only for those vehicles registered with Alberta plates and only if the carrier has declared that they are a “federal” company. If an Alberta carrier also has a commercial vehicle, regulated by the NSC requirements of another jurisdiction, then they will need a second SFC from that jurisdiction.

Each jurisdiction monitors its own NSC carriers and intervenes with those that pose an unacceptable risk to the public. Where a carrier does not respond positively to intervention actions and continues to represent an unacceptable risk to the public, the carrier may be prevented from operating by canceling their SFC and their commercial vehicle registrations.

## Safety plans

In Alberta, a carrier must establish, maintain and follow a written safety program. A carrier failing to complete this regulatory requirement may be subject to disciplinary action including charges being laid in the courts, an administrative penalty being issued, or their Safety Fitness Certificate being cancelled. A carrier’s Safety Plan must address matters relating to the safe use and operation of their commercial vehicles including:

- speed limits, seat belt use, drug and alcohol use, defensive driving, load security, and fuelling
- proper records and recording of information including, as required, bills

of lading, manifests, dangerous goods documents, time records, drivers' daily logs and weigh slips

- policy and procedures related to compliance with the law, driver training responsibilities, conduct and discipline
- instructions for the use of safety equipment including, as required, the use of reflective triangles, fire extinguishers, goggles, and hard hats
- training for employees about safety laws and their application and an ongoing program for evaluating their driving skills
- retention of complete records for each driver in accordance with regulations
- policies for ensuring that drivers are properly qualified for the type of vehicle they operate

All drivers have a responsibility to know and follow the policies and procedures contained in their company's safety plan.

Each driver should:

- have received the training specified in the company's safety plan and know how to perform their duties properly and safely (e.g. training on drivers' hours of service, trip inspections, cargo securement, weights and dimension requirements, etc.)
- ensure that the vehicle is being operated in compliance with the owner's policies and procedures, and within the law
- have all the applicable documentation completed and in his or her possession when required (e.g. Bills of Lading and Dangerous Goods documents)
- be medically fit to drive and not fatigued or under the influence of alcohol or any drug
- be qualified to operate the vehicle and have any required documents, such as a valid driver's licence, vehicle

registration and Dangerous Goods training certificate and insurance

- report any violations, convictions, and collisions to the carrier

For more information, refer to the Commercial Vehicle Certificate and Insurance Regulation AR 314/2002, which is available from the Queen's Printer. (See "*Need more information*" at the end of this section.)

## Preventive maintenance plans

In Alberta, a carrier must establish, maintain and follow a written maintenance and inspection program that covers all applicable vehicles registered to the carrier in Alberta, **including leased vehicles.**

A carrier failing to complete this regulatory requirement may be subject to disciplinary action including charges being laid in the courts, an administrative penalty being issued, or their Safety Fitness Certificate being cancelled. The policies and procedures set out in the maintenance program must provide for continuous and regular inspections that meet the requirements specified in the regulations.

Every driver is responsible to:

- understand the company's maintenance plan
- carry out those inspections and maintenance required by the owner
- carry out any inspections required by legislation, such as vehicle trip inspections
- complete any documents required by the owner and return those documents to the owner

# Provincial (Alberta) legislation

- ensure the vehicle is inspected, or make it available for inspection, as specified in the company's preventive maintenance plan
- report any on-road inspections received from an enforcement officer and provide the documents to the carrier
- notify the carrier of any defects found during an inspection;
- not operate any vehicle with a defect that would jeopardize the safety of the driver or any other person

For more information, refer to the Commercial Vehicle Safety Regulation, AR 121/2009 which is available through the Queen's Printer. (See **“Need more information”** at the end of this section.)

## Hours of service

Hours of service legislation is safety legislation that ensures commercial drivers have enough opportunities to rest so they do not drive when tired.

There is both federal and provincial legislation that regulates drivers' hours of work. Alberta legislation applies to carriers and their drivers who operate vehicles solely within Alberta. The federal legislation applies to carriers and their drivers who operate one or more vehicles outside of Alberta. Once it has been determined that a carrier falls within the federal legislation, all the drivers of the carrier's regulated vehicles must comply to federal requirements, even those that never leave Alberta. The main regulatory requirements are summarized below. To fully understand all requirements, one must read the applicable regulations.

The on-duty hours (consisting of “driving” and “on-duty not driving” time) allowed for a driver are regulated in **work shifts** that generally start after having a period of eight consecutive hours off-duty and end when the driver has another period of eight consecutive hours off-duty. Some situations are considered equivalent to this eight hour off-duty requirement.

During a work shift, a driver cannot drive:

- after having driven 13 hours; or
- after being on-duty for 15 hours

A driver must account for every day by completing a daily log for each calendar day, or indicating in the remarks section of the daily log that the driver was off-duty on the indicated dates.

When required to complete a daily log, a driver must do the following:

- enter all the required information
- maintain the daily log current to the last change of duty status, such as off-duty time and driving time
- maintain the daily log accurately
- keep copies of documents received during the trip, such as hotel receipts and fuel receipts
- deliver the daily log, and all supporting documents, to the employer within 20 days
- keep a copy of each daily log and supporting documents for at least six months

If ALL of the following four conditions are met, a daily log is not required to be completed. (however, all other regulated requirements must still be met):

- the driver starts and ends the work shift at the same place
- the driver stays within a 160 kilometre radius of the home terminal
- there must be no more than 15 hours from the time the driver starts work until relieved of duty
- the employer must maintain a record for at least six months of the time each driver starts and ends a work shift

The driver's employer must:

- ensure the driver follows the regulations; and
- maintain the daily logs, in an orderly manner, for each driver for six months

For more information, refer to the Drivers Hours of Service Regulation AR 317/2002, which is available from the Queen's Printer. (See ***"Need more information"*** at the end of this section.)

## Federal legislation

The federal drivers' hours of service regulations are more restrictive than the Alberta regulations. It is important to realize that the federal regulation has daily, work shift and cumulative cycle limits that all must be met every day. The following is only a summary of the main regulatory requirements.

During a **day** (a consecutive 24 hour period determined by the carrier) a driver cannot drive:

- after having driven 13 hours; or
- after being on-duty for 14 hours

In each day a driver must take 10 hours of off-duty time, 8 of the hours off being

consecutive. The other two hours must be taken in no less than 30 minute periods. Some concessions apply.

During a **work shift** (a work shift starts after the driver has 8 consecutive hours off), a driver cannot drive:

- after having driven 13 hours;
- after being on-duty for 14 hours;
- after 16 hours of time has elapsed since the conclusion of their most recent 8 hours of consecutive off-duty time

Sleeper berth requirements differ between team and single drivers.

A carrier must ensure their drivers are following cycle 1 or 2. The driver must then indicate which cycle they are operating under on their daily log. Depending on the cycle, the driver shall not drive after accumulating:

**Cycle 1** - 70 hours of on-duty time in 7 consecutive days; or

**Cycle 2** - 120 hours of on-duty time in 14 consecutive days.

Drivers using cycle 2 are required to take at least 24 consecutive hours off prior to reaching their 70th hour of on duty time.

A driver operating on cycle 1 may reset their accumulative hours back to zero by taking 36 consecutive hours off-duty. A driver operating on cycle 2 may reset their accumulative hours to zero by taking 72 consecutive hours off-duty. A driver cannot move from one cycle to the other without taking a reset.

No driver may drive unless they have taken at least 24 consecutive hours off in the preceding 14 days.

A driver need not complete a daily log if:

- the driver operates or is instructed by the motor carrier to operate a commercial vehicle within a radius of 160 kilometres of the home terminal



- the driver returns to the home terminal each day to begin a minimum of 8 consecutive hours of off-duty time
- the motor carrier maintains accurate and legible records showing, for each day, the driver's duty status and elected cycle, the hour at which each duty status begins and ends and the total number of hours spent in each status and keeps those records for a minimum period of 6 months after the day on which they were recorded and
- the driver is not driving under a permit issued under these Regulations

If a radius exemption from completing a log is used, all other requirements of the regulation must still be met.

For more information, refer to the Commercial Vehicle Drivers Hours of Service Regulation SOR/94-716, which is available from the Queen's Printer.

## Need more information?

To learn more about this legislation or to ask questions about the requirements, check the following.

Alberta legislation is available from the Queen's Printer at:

<http://www.qp.alberta.ca>

or phone 780-427-4952.

For toll-free service from anywhere in Alberta, call 310-0000

More information is available at:

<http://www.transportation.alberta.ca>

## Vehicle Safety and Carrier Services

Room 401, Provincial Building  
4920 – 51 Street

Red Deer, Alberta

T4N 6K8

403 340-5021

For toll-free service from anywhere in Alberta, call 310-0000

## Vehicle Inspection Program (VIP) for Commercial Vehicles

To maintain and enhance the safety of commercial vehicles travelling on Alberta highways, the province has a mandatory safety inspection program. This is called the Alberta Vehicle Inspection Program (VIP) for Commercial Vehicles.

The VIP for Commercial Vehicles is not a replacement for the ongoing preventive maintenance carried out by vehicle owners, but rather sets the standards for owners' maintenance programs.

A commercial vehicle passing inspection under VIP will receive a Commercial Vehicle Inspection Certificate, as well as a Commercial Vehicle Inspection decal to be placed on the vehicle.

As with the National Safety Code, municipal transit buses and farm trucks are exempt when operating solely within the borders of Alberta from the VIP.

# Which commercial vehicles need to be inspected under Vehicle Inspection Program?

## BUSES

All buses designed to carry more than 11 passengers, including the driver, must be inspected. This does not include municipal transit buses, but does include both school buses and commercial buses. Buses must be inspected every six months. Since 1978, Alberta has had a semi-annual inspection requirement for buses.

## TRUCKS AND TRAILERS

All trucks, truck-tractors, trailers and semi-trailers with a registered combined gross vehicle weight (GVW) of 11,794 kg or more must be inspected. Trucks and trailers must be inspected every 12 months. These are the same vehicles as governed under the National Safety Code.

## How can I find out more about the Vehicle Inspection Program for Commercial Vehicles in Alberta?

For more information about inspection of commercial vehicles in Alberta, or to apply for a Vehicle Inspection Program Facility Licence or a Vehicle Inspection Program Technician Licence to inspect Commercial Vehicles, contact:

### Vehicle Safety

Main Floor, Twin Atria Building  
4999 – 98 Avenue  
Edmonton, Alberta T6B 2XB  
780-427-8901

For toll-free service from anywhere in Alberta, call 310-0000.

**NOTE:** Please request to speak to the Vehicle Inspection Program Licensing Analyst.

## Cargo securement

It is important to ensure that all cargo carried by a commercial vehicle is properly secured according to the requirements of the Canadian National Safety Code (NSC) Standard 10, adopted in Alberta's Commercial Vehicle Safety Regulation.

Commercial trucks registered over 4500 kg are required to ensure the cargo they carry is secure:

- A carrier shall not permit a driver to operate a commercial vehicle where the cargo transported in or on the vehicle is not contained, immobilized, or secured in accordance with the NSC Standard as it relates to the particular type of commercial vehicle.
- A driver shall not operate a commercial vehicle where the cargo transported in or on the vehicle is not contained, immobilized, or secured in accordance with the NSC Standard as it relates to the particular type of commercial vehicle.
- A driver or carrier must ensure that cargo transported by a commercial vehicle is contained, immobilized or secured so that it cannot:
  - leak, spill, blow off, fall from, fall through or otherwise be dislodged from the vehicle
  - shift upon or within the vehicle to such an extent that the vehicle's stability or ability to move is adversely affected.

If cargo is not properly secured, the driver, carrier, or shipper could face fines and penalties.

The North American Cargo Securement Standard can be viewed on the Canadian Council of Motor Transport Administrators website at; [www.ccmta.ca](http://www.ccmta.ca)

3

# Trip Inspections

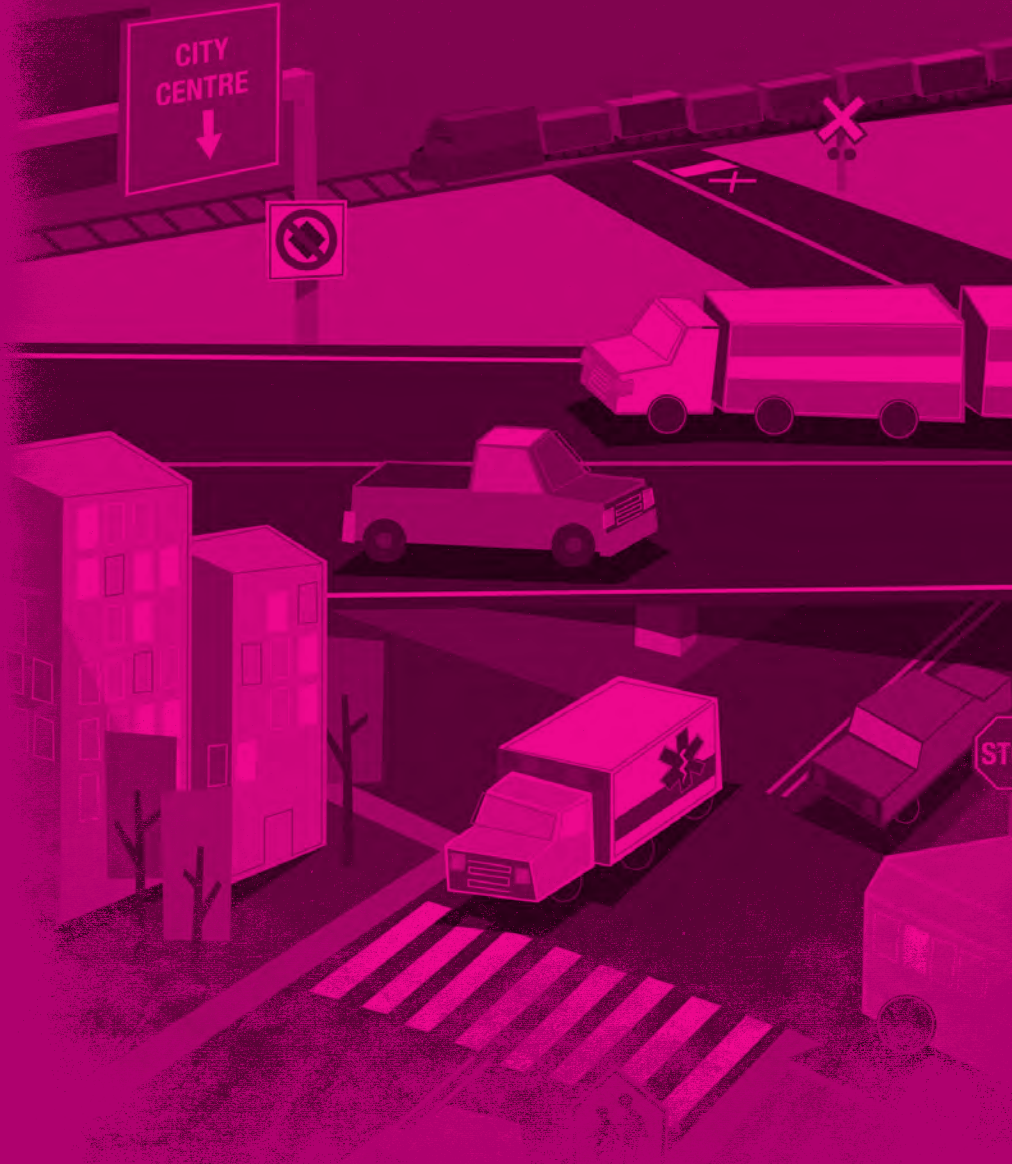

# Purpose of daily vehicle inspections

The purpose of a daily vehicle inspection is to ensure the early identification of a vehicle problem and defects before the vehicle is operated on the highway. Inspections prevent the operation of a vehicle with conditions that are likely to cause or contribute to the severity of a collision.

The trip inspection process is part of a carrier's legal requirement to have and implement a written maintenance program. It also ensures there is clear communication within the company about the vehicle's day-to-day safety.

Inspection reports serve as communication between drivers, the carrier and the carrier's maintenance department. Reports are used to verify inspections, record defects, report defects and may be used to verify repairs. Reports are completed immediately following an inspection.

A brief overview of the daily inspection program includes:

- The driver conducts an inspection on a vehicle or combination of vehicles.
- The inspection is conducted with the use of a schedule which lists the vehicle components and systems that require inspection.
- The driver completes a report of the inspection.
- The inspection and report are valid for 24 hours.
- The driver is to carry the schedule and report in the vehicle.
- The driver records any defects found during the inspection, while en route and at the end of the trip or day.
- The driver reports defects to the carrier.

# Vehicles that require inspections

Provincially regulated carriers (those that operate solely within Alberta) must complete trip inspection reports on:

- Trucks registered for a weight of 11,794 kilograms and greater; and
- Commercial passenger vehicles with a designed seating capacity of 11 or more persons, including the driver.

Federally regulated carriers (those that operate one or more vehicles outside the province of Alberta) must complete trip inspection reports on:

- Trucks registered for a weight of 4,500 kilograms and greater; and
- Commercial passenger vehicles with a designed seating capacity of 11 or more persons, including the driver.

A "commercial vehicle" is defined as a vehicle operated on a highway by or on behalf of a person for the purpose of providing transportation but does not include a private passenger vehicle.

# Vehicle defects

## Recording defects

The driver is required to record a defect on the report immediately after the initial inspection or upon discovery of a defect while travelling or when discovered at the end of a trip or day.

## Reporting defects

For the purposes of reporting defects to the carrier, the carrier may designate an employee to receive reports of defects.

Minor and major defects, which are listed in a schedule, must be reported immediately by the driver or inspection person to the carrier upon discovery of the defect.

Depending on the driver's situation, reporting defects to the carrier may be done in person, by phone, via written report or by electronic means.

## Driving with defects

A driver may continue to drive with a minor defect that is listed on an inspection schedule if the driver has immediately entered the defect on the daily inspection report and reported the defect to the carrier.

## Vehicle not to be operated with a major defect

No carrier shall permit a person, and no person shall, drive a commercial vehicle on a highway when a major defect that is listed on an inspection schedule is present on the vehicle.

## Driver inspection required

The driver is required to complete and sign a report upon completion of the inspection. Drivers are not permitted to drive a truck or tow a trailer unless the driver or another person has conducted an inspection of the

vehicle(s) within the previous 24 hours.

In addition to the initial inspection, whether conducted by the driver or not, the driver is required to monitor the condition of the vehicle(s) for defects while en route.

In addition to drivers, other persons such as maintenance or yard staff are also permitted to conduct inspections and complete and sign reports.

Where a trip inspection report has been completed, the trip inspection is valid for a maximum of 24 hours. This means a trip inspection conducted by a person may be used by another person provided it was completed within 24 hours.

A person other than the driver who conducts an inspection and signs the report is responsible under law for the inspection and the information contained in the inspection report. The driver may rely on such an inspection and produce the report to an officer, unless the driver has reason to believe the inspection and report do not meet the requirements, or the driver is aware or ought to be aware that the vehicle has a defect.

Any number of trailers may be inspected and added to a single report if the report contains additional lines for additional trailers.

All information required to be on a report must be accurately completed in full.

On the demand of a peace officer, a driver must produce the inspection schedule and the written trip inspection report. Alberta's trip inspection legislation is contained in sections 9 through 16 of the Commercial Vehicle Safety Regulation 121/2009 and can be viewed on the Queen's Printer web site at: [www.qp.alberta.ca](http://www.qp.alberta.ca)

There are vehicle inspectors throughout the province who conduct commercial vehicle inspections. Vehicles that do not meet the requirements can be taken out-of-service until the repairs are made. This can also result in fines and points assessed on the Carrier Profile or the driver's Commercial Driver Abstract.

## Trip inspection schedule

### Application of inspection schedule

- A truck, a tractor and towed trailer are inspected using Schedule 1. A converter dolly is inspected as part of the trailer it is carrying. The dolly is to be inspected again when carrying a different trailer.
- Carriers are required to supply drivers with a copy of the inspection schedule.
- Drivers are required to carry and produce the inspection schedule to an officer.
- A schedule and an inspection report may be combined on the same document.

### Where to get inspection schedules

Schedule 1 - 4 of *National Safety Code Standard 13*, which is published by the Canadian Council of Transport Administrators (CCMTA), is acceptable in Alberta, including when produced by the driver of an Alberta plated commercial vehicle. These schedules may be viewed at: [www.ccmta.ca](http://www.ccmta.ca). Some companies,

associations and organizations also produce and sell schedules and report forms.

## Trip inspections

### Inspection procedures

**NOTE:** *Only the driver is referenced as the inspection person throughout the remainder of this chapter.*

Drivers may choose an inspection procedure (circle procedure) that best suits the vehicle and its location. However, whichever procedure is used, each regulated inspection item must be inspected and where a defect is discovered the defect must be recorded on the report and reported to the carrier.

The following detailed trip inspection is for reference only. Check with your employer to determine if the company has its own forms for recording vehicle condition.

**NOTE:** *A vehicle trip inspection is required as part of the road test when applying for a Class 1, 2 and 3 driver's licence.*

### Before beginning the inspection

- Choose terrain that is as level as possible and park the vehicle safely away from traffic.
- Set parking/spring brake. Place the transmission in low gear for a manual transmission.
- Shut off the engine.



- ❑ Chock the wheels and ensure the chocks will keep the vehicle from moving especially for vehicles equipped with air brakes when they are released later. The minimum size for square blocks should be 15 by 15 centimetres.

## Circle check

The drawings below illustrate one way to make a full circle check. Do a walk-around check before starting any trip. The circle check may be done in any order, but make sure that you check everything and always make a complete circle around the vehicle. Much of the pre-trip information listed below is common to all commercial vehicles. Where there are extra items for specific vehicle types, it is indicated under its own heading.

**NOTE:** The categories for a bus includes; commercial, school and private buses. Unique school bus items, if applicable are noted.

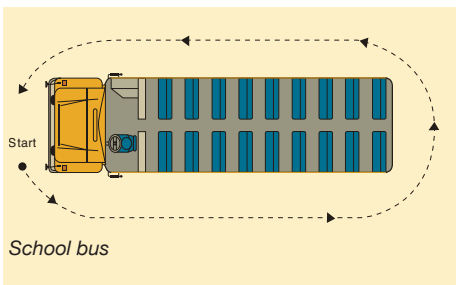
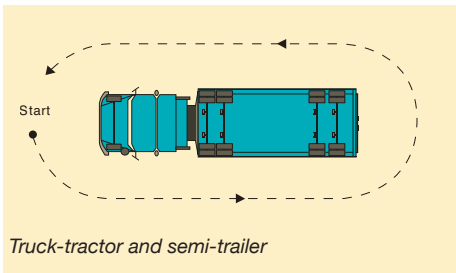
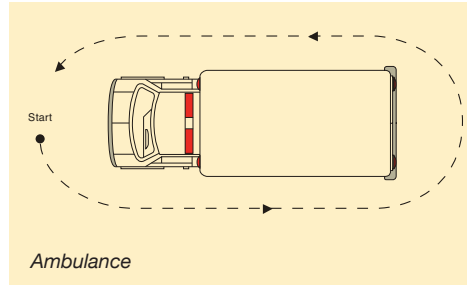
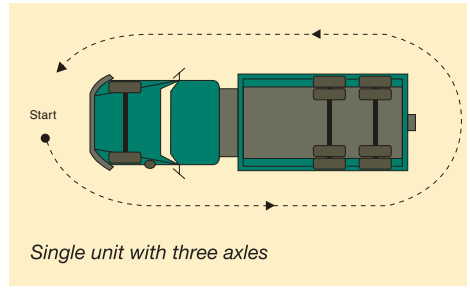

## Daily walk-around procedure – items to check:

Starting at the front of the vehicle and going down the driver's side of the vehicle, from the front to the back, check the following:

### OUTSIDE OF THE VEHICLE

#### Under the hood

#### All vehicle types

- ❑ radiator has no leaks, has adequate coolant level and proper fitting cap
- ❑ fan has no bent, cracked, missing blades or loose mountings
- ❑ all belts have correct tension and do not show signs of wear
- ❑ oil and other fluid levels are adequate
- ❑ air filter for condition
- ❑ battery has no cracks, excessive corrosion or leaks, terminal connections are secure, battery is securely mounted (battery location varies on different vehicles)

- steering mechanism has no bent, broken or missing parts, power steering pump and hose for leaks and adequate fluid level, steering mechanism has no wear or excessive play
- all hose connections are secure, have no leaks, kinks, cuts, abrasions or cracks
- shock absorbers are not loose or leaking (if visible on the vehicle)
- suspension has no cracked, missing or broken leaf springs, or U-bolts that are loose, broken or missing (if visible on the vehicle)

### Vehicles with Air Brakes

- air compressor is securely mounted, condition of lines, fittings, hoses and couplers
- brake chambers for condition and security
- slack adjuster angle, push rod travel, mechanical condition and wear
- air lines have no leaks, kinks, cuts, abrasions or cracks

**NOTE:** During the pre-trip inspection, return to the driver's compartment as required to turn the lights on and off to check that they are working properly.

## FRONT OF VEHICLE

### All Vehicle types

- no traces of leaking fluids on the ground under the vehicle
- high and low beam headlights work, lenses are clean and not cracked
- hazard warning lights work, lenses are clean and not cracked

- right and left turn signals work, lenses are clean and not cracked
- clearance and marker lights work, lenses are clean and not cracked, and reflectors are clean
- windshield is clean and free of major cracks

### Truck-tractor

- licence plate is valid, clean and secure

### Bus

- alternating amber and red flashing lights work, lenses are clean and not cracked (school bus only)
- pedestrian-student safety crossing arm is secure, not damaged and works (school bus only)
- clearance and marker lights work, lenses are clean and not cracked, reflectors are clean
- crossover mirror is secure, clean and not cracked (school bus only)

### Ambulance

- emergency lights work, lenses are clean and not cracked

## DRIVER'S SIDE OF THE VEHICLE

### All Vehicle Types

- steering axle tire has adequate tread depth (not less than 3.2 mm), proper inflation, no bulges, sidewall separation, cuts or uneven wear
- steering axle rim has no cracks, missing pieces, bends or rust streaks, wheel fasteners are secure and not missing, broken or loose

- oil level in steering axle wheel bearing, if equipped
- inspection decal is present, valid and in the proper location (if required for the specific vehicle)
- mirrors are attached securely and not cracked
- driver's door operates properly (does not apply to a bus)
- windows are clean
- fuel cap is present and secure (fuel cap location may vary on each vehicle)

### **Truck-tractor and three axle vehicles**

- handrail is secure
- steps are secure and in good condition
- fuel tank has no leaks, tank is secure, the air vent is not plugged and that the proper fitting cap is secure
- fuel system lines are secure and have no leaks
- exhaust system is in good condition, has no leaks, muffler is securely attached, and the heat shield (if present) is secure
- storage compartment doors open and close properly and contents are secure
- first drive axle tires have adequate tread depth (not less than 1.6 mm), proper inflation, no bulges, sidewall separation, cuts or uneven wear, dual tires are not touching and nothing is trapped between them
- first drive axle wheel rims have no cracks, missing pieces, bends or rust streaks, wheel fasteners are secure and not missing or broken
- second drive axle tires have adequate tread depth (not less than 1.6 mm), proper inflation, no bulges, sidewall separation, cuts or uneven wear, dual tires are not touching and nothing is trapped between them
- second drive axle wheel rims have no cracks, missing pieces, bends or rust streaks, wheel fasteners are secure and not missing, broken or loose
- fifth wheel coupler bolt is secure, slider is locked and secure, plate shows no damage, cracks or weld separations, plate is flush to the apron (no daylight is visible between them)
- fifth wheel locking jaws are closed, plate sits flat on the underside of trailer, kingpin is enclosed
- kingpin and pintle hitch eyehook (if equipped) is not worn, damaged, cracked or broken
- hitches (if equipped), pintle hitch or ball hitch is not worn and locking mechanism is closed
- chains, cables (if equipped) have no stress cracks or weld breaks and are securely attached
- drive shaft is in good condition and there are no obstructions
- suspension has no cracked, missing or broken springs, torsion bars or walking beams are secure and not damaged, no loose, missing, or broken U-bolts, shock absorbers are securely mounted and not leaking. If a vehicle has air suspension, check for damaged, worn or inoperative air bags
- axle assembly has no breaks, cracks, holes, broken seals or bends
- signal lights work, lenses are clean and not cracked
- brake lights work, lenses are clean and not cracked (whenever possible, have another person activate the brakes while you check for proper operation)
- backing and docking lights work, lenses are clean and not cracked (whenever

possible, have another person activate the controls while you check for proper operation)

- brake chambers are secure, no signs of cracks, corrosion or holes and nothing obstructs the push rod travel
- slack adjusters - pull manually or use a pry bar to check for travel, mechanical condition and wear
- air lines are secured, no leaks, kinks, cuts, abrasions or cracks in housing
- mud flap is secure and does not rub tires
- body has no damage, broken or missing rivets, holes or weld separations.

## Bus

- stop arm is secure and not damaged (school bus only)
- body has no damage, broken or missing rivets, holes or weld separations
- frame and structural supports have no holes, bends, cracks, weld separations or broken cross members
- retro-reflective tape is clean (school bus only)
- clearance and marker lights work, lenses are clean and not cracked, reflectors are clean
- suspension has no cracked, missing or broken springs, no loose, missing or broken U-bolts

## Ambulance

- clearance and marker lights work, lenses are clean and not cracked, reflectors are clean
- drive axle tire has adequate tread depth (not less than 1.6 mm), proper inflation, no bulges, sidewall separation, cuts or

uneven wear, dual tires if equipped are not touching and nothing is trapped between them

- drive axle wheel rim has no cracks, wheel fasteners are secure and not missing

## Driver's front and side of a trailer (if equipped)

- inspection decal is present, valid and in the proper location
- body has no damage, broken or missing rivets, holes or weld separations
- frame and structural supports have no holes, bends, cracks, weld separations or broken cross members
- landing gear is raised, handle is secure, there are no cracks or breaks in cross members or webbing, lowering mechanism is secure
- air lines are secured safely, there are no leaks, kinks, cuts, abrasions or cracks in housing
- clearance and marker lights work, lenses are clean and not cracked, reflectors and retro-reflective tape is clean
- load security devices work, anchor points are secure, vehicle and load devices are not damaged
- first trailer axle tires have adequate tread depth (not less than 1.6 mm), proper inflation, no bulges, sidewall separation, cuts or uneven wear, dual tires are not touching and nothing is trapped between them
- first trailer axle wheel rims have no cracks, missing pieces, bends or rust streaks, wheel fasteners are secure and not missing or broken
- second trailer axle tires have adequate

- tread depth (not less than 1.6 mm), proper inflation, no bulges, sidewall separation, cuts or uneven wear, dual tires are not touching and nothing is trapped between them
- second trailer axle wheel rims have no cracks, missing pieces, bends or rust streaks, wheel fasteners are secure and not missing, broken or loose
- sliding tandem and locking pin - the pin is locked and secure, no bends, cracks, breaks or weld separations in the cross members, torsion bars or flanges
- brake chambers are secure, have no cracks or corrosion, and nothing will obstruct the push rod travel
- all slack adjusters - pull manually or use a pry bar to check for travel, mechanical condition and wear
- suspension has no cracked, missing or broken springs, torsion bars or walking beams are secure and not damaged, no loose, missing or broken U-bolts. If the trailer has air suspension, check for damaged, worn or inoperative air bags
- axle assembly has no breaks, cracks, holes or cracked seals.
- licence plate is clean, attached securely, the registration decal is valid, licence plate light is secure and works, and the lens is clean
- doors or gates work, are closed and secure (if applicable)
- rear windows are clean (if applicable)
- mud flaps are secure and do not rub on the tires
- exhaust system is secure and has no visible leaks, muffler is securely attached (if applicable)

## Bus

- alternating amber and red flashing lights work, lenses are clean and not cracked (school bus only)
- white flashing strobe light works (school bus only)
- clearance and marker lights work, lenses are clean and not cracked, reflectors (retro-reflective tape is clean for school bus only)
- rear door opens properly, closes securely, emergency buzzer works and rear door seal is not damaged (school bus only)
- specialized equipment for transporting persons with disabilities is operating and is secured properly, if equipped
- spare tire, if equipped, is inflated and secure, jack and tools are properly secured.

## Ambulance

### Patient compartment

- medical equipment is stowed properly and inventory is completed
- fire extinguisher is fully charged and label indicates that it has not expired, an approved warning device is present

## REAR OF A VEHICLE

### All Vehicle Types

- right and left turn signals work, lenses are clean and not cracked
- hazard warning lights work, lenses are clean and not cracked
- brake lights work, lenses are clean and not cracked (whenever possible, have another person activate the brakes while you check for proper operation)
- clearance and marker lights work, lenses are clean and not cracked, reflectors and retro-reflective tape (if applicable) is clean

## PASSENGER SIDE OF A VEHICLE

### All Vehicle Types

Continue inspecting the passenger side of the unit using the same procedures as on the driver's side of the truck-tractor and semi-trailer.

#### Bus

- fuel filler cap is present and secure
- passenger door operates smoothly and closes securely from the inside
- steps are clean and step light works, if equipped
- inspection decal is present, valid and in correct location.

## INSIDE THE VEHICLE AND ENGINE START UP

### All Vehicle Types

- seat and mirrors are adjusted properly
- seat belt is adjusted and fastened properly
- feel and operation of brake pedal and clutch pedal (if equipped)
- steering has no excessive play or slack
- all gauges and warning lights work
- fuel level is adequate
- windows are clean, windshield is clean and free of major cracks
- windshield wipers work, washer has adequate fluid and sprays well
- defroster and heater work properly
- horn works and backing alarm works properly if equipped - some regulations require a backing alarm when vehicles are around workers on foot
- engine runs smoothly
- there are no unusual engine noises

- there is no unusual noise when the clutch is pushed in and released while the transmission is in neutral for a manual transmission (if applicable)
- radio equipment and P. A. system work and siren works in all modes (if applicable)

#### Truck-tractor

- hand throttle and accelerator pedal operate properly
- air pressure build-up time is adequate and the air pressure drop does not exceed an acceptable amount when the brakes are applied
- service brakes have been tested by driving forward slowly and stopping

#### Bus

- handrail is secure
- fire extinguisher is fully charged and label indicates that it is valid, an approved warning device is present
- first aid kit is fully equipped
- all emergency exits open and close properly (the alarm system is working for school bus only)
- parking brake works
- stop arm and lights work (school bus only)
- passenger seats are securely fastened to the floor and are in good condition
- the interior for cleanliness and damage
- restraints for the wheelchair work and are secured, if equipped

# Extra equipment and documentation

## All Vehicle Types

- fire extinguisher is fully charged and label shows that it has not expired
- an approved warning device is present
- first aid kit is fully equipped
- all necessary documentation is in the vehicle. This could include the vehicle registration and valid insurance, Vehicle Inspection Program (VIP) inspection certificate, pre-trip inspection form, safety fitness certificate, permits, logbook, are valid and any other supporting documents.
- all personal protective equipment that is required before going on a work site is present
- tools are properly secured
- spare light bulbs, fuses, belts and other required parts are present.

# Trip air brake inspection

The following information is a guide only. As in the trip inspection of the vehicle, the driver plays an important role in maintaining the air brake unit. A driver must be alert and know how the air brake system works. Any brake problems must be reported so the necessary repairs can be done.

## Step 1

- Chock the wheels with the vehicle on level ground.
- Perform a visual inspection of the air brake components.

## Step 2 (Tractor protection system)

- Leave the engine off with the key in the 'run' position.
- Push the trailer air supply valve (red button); the park control valve (yellow button) should be pulled.
- Disconnect both air lines to the trailer.
- Trailer air supply valve should "pop" out at 40 - 60 PSI (276 - 414 kPa) or higher.
- Low air pressure warning should come on by 60 PSI (414 kPa).
- Apply and hold foot or hand valve; no air should leak from the open trailer service line.

## Step 3 (Park control valve)

- Push park control valve (yellow button).
- Pump the foot valve.
- Park control valve should "pop" out at 20 - 45 PSI (138 - 311 kPa).
- Reconnect both air lines to the trailer.

## Step 4 (Supply circuit)

- Start the engine and run at fast idle around 1200 RPM.
- Perform compressor build-up test; 50 to 90 PSI (345 to 621 kPa) within 3 minutes.
- Low air pressure warning light should go out by 60 PSI (414 kPa).
- Build air pressure to system maximum to confirm governor cut-out at 120 - 135 PSI (828 - 931 kPa).
- Pump service brakes to reduce air pressure until governor cuts in. Confirm cut-in is 20 - 25 PSI (138 - 172 kPa) less than cut-out pressure.



## Step 5 (Air system leaks)

- Push both park control valves and rebuild air pressure.
- Turn off the engine.
- Apply and firmly hold a full service brake application for 2 minutes.
- Maximum 4 PSI (28 kPa) loss for power units, plus an additional 2 PSI (14 kPa) per trailer, after the system stabilizes.
- Release service brake application and reapply spring park brakes.

## Step 6 (Service brake response)

- Remove wheel chocks.
- Release spring park brakes.
- Perform a brake response test using the foot valve.
- Perform a brake response test using the trailer hand valve.

## Enroute check stop inspections

Rest and check stops serve two purposes. First, they provide a break and a change of routine. You will feel less tired and more alert after a rest stop. Second, you can check your vehicle after it has been on the road for some time. You will be able to see if everything is still secure and working the way it should.

Schedule rest and check stops according to National Safety Code (NSC) requirements and your company's policy.

When choosing a stop, keep the following in mind:

- Make sure the vehicle is completely off the road.

- You should be able to enter and exit a rest or check stop so that you do not have to back the vehicle.
- Do not make a stop at the bottom of a hill or on an uphill slope.
- The stop area should have an adequate acceleration lane to allow you to merge on to the highway at the appropriate speed.

A vehicle inspection at a rest and check stop should include the following:

- All lights are clean and in working order.
- There are no air leaks.
- All the wheels are secure, and tires are properly inflated and are not hot.
- There are no broken or loose items on the vehicle.
- The load is secure.
- The dangerous goods placards are clean and secure (if applicable).
- The trailer locking mechanisms are secure and in good condition.
- The brakes are properly adjusted.

## Reporting to a vehicle inspection station

One of the most common misconceptions regarding vehicle inspection stations is that only large commercial vehicles have to report. The law is that all commercial vehicles or combinations weighing over 4,500 kg are required to report to inspection stations when the highway lights are flashing. A "commercial vehicle" is defined as a vehicle operated on a highway by or on behalf of a person for the purpose of providing transportation but does not include a private passenger vehicle.

If you are operating a motor vehicle that is required to report, if the vehicle is loaded, drive slowly across the scale lane. If empty, drive slowly in the lane beside the scale lane. Whether loaded or empty watch the light board for instructions. If the “STOP” light is activated, stop the vehicle and wait for further instructions. If the “BACK UP” light is activated, slowly and safely back the vehicle up keeping in mind there may be other vehicles behind you. If the “PARK” light is activated park the vehicle in the lot and bring all of the vehicle and driver documents to the scale building

- check the condition of the emergency equipment
- report any minor damage and fluid leaks under the bus
- check the tires for damage and air leaks

## Post-trip inspection

At the end of a shift, it is recommended you do a post-trip inspection. This will enable you to obtain service or repairs if required before the next trip. The report should include any problems discovered during the trip. Waiting to do the inspection can result in problems that are frustrating, time consuming and costly.

### Post-trip inspection for school buses

A school bus is subject to considerable wear and tear. It travels in poor weather conditions, often over difficult roads, and is usually full of lively children. For this reason, it is important that you inspect the bus both inside and outside at the end of every trip.

You will need to do the following:

- inspect the bus for lost articles and children who are sleeping or still on the bus
- clean the floors, particularly around the front steps



4

# Operating Class 1 Vehicles

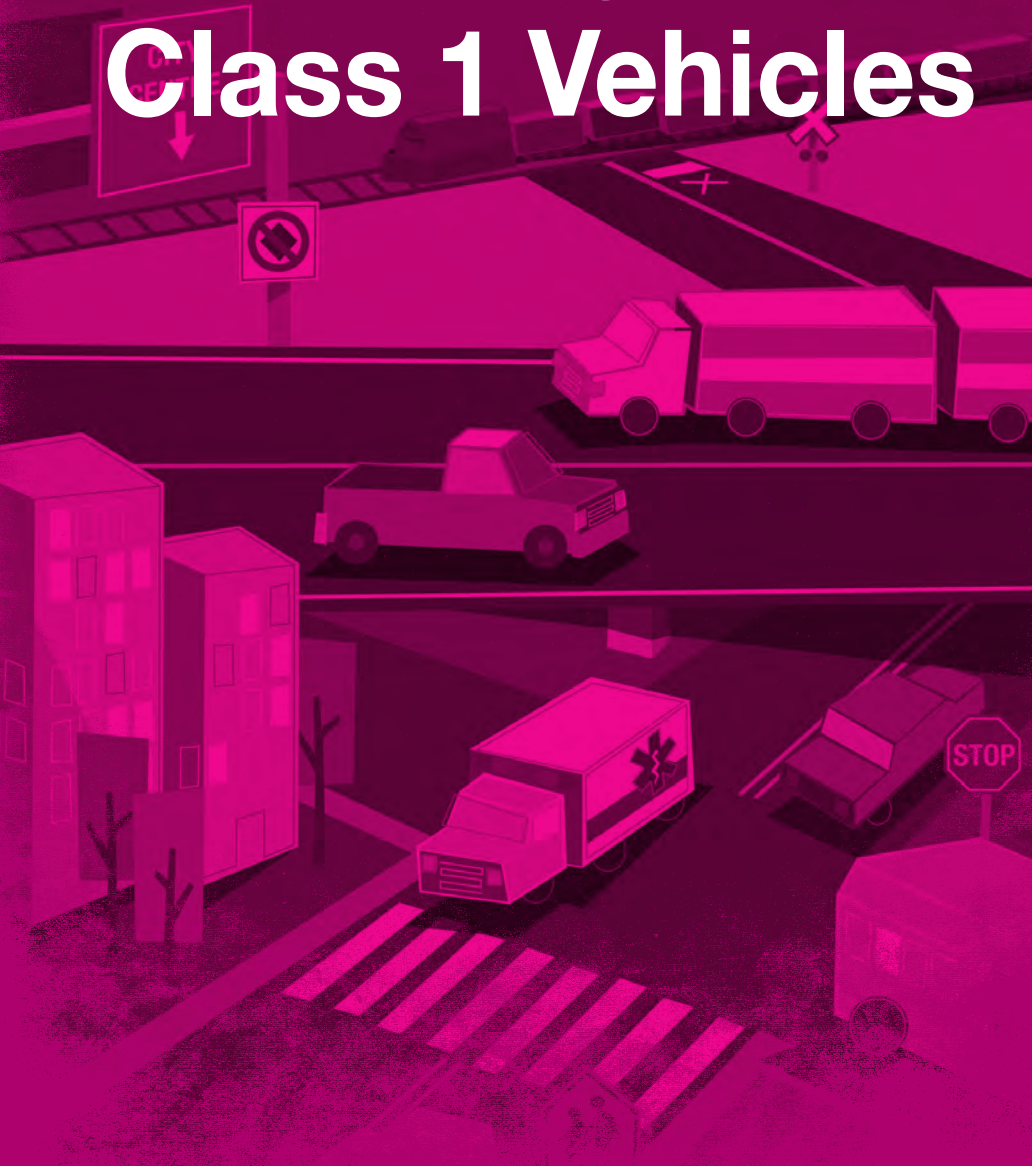

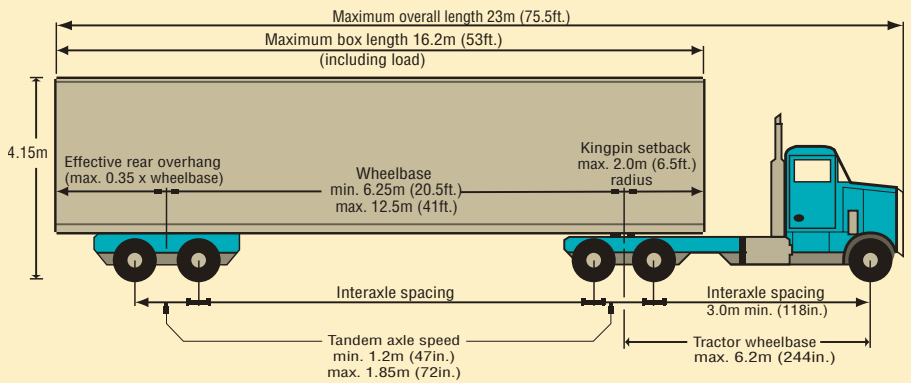

## Operating a truck-tractor and semi-trailer

### Size and weight restrictions of commercial vehicles

Commercial vehicles must not be more than the following dimensions:

- 2.6 metres in width. If the vehicle is wider than 2.05 metres, clearance lights are required. These must be amber in the front and red in the rear.
- 4.15 metres in height from the ground surface
- 12.5 metres in length for a straight truck
- 6.2 metres in wheelbase length for a truck-tractor
- 23 metres in overall length for a tractor semi-trailer or truck and towed trailer combination
- 25 metres in overall length for Transportation Association of Canada (TAC) vehicle combinations consisting of A, B and C trains.

No vehicle or combination of vehicles will be allowed to operate on a highway if the weight on a tire, axle or axle groups or gross vehicle weight is more than what is allowed under the *Commercial Vehicle Dimension and Weight Regulation (AR 315/2002)*.

Specialized, oversized or overweight equipment requires a special permit. The permit will have specific conditions on it. These conditions will state:

- the routes you may travel on
- the days and hours of travel
- the type of equipment that must be used
- anything else that is needed to prevent road damage and to ensure safety.

## Air Brakes

Detailed air brake information can be found in the Alberta Air Brake Manual. This Manual will be given to you when you complete the Alberta Air Brake Program at a licensed driving school or certified

delivery agent. You must complete the Program in order to obtain the air brake “Q” endorsement on your driver’s licence. This endorsement is required to operate any vehicle with air brakes.

## How long does it take to stop a vehicle?

In order to stop a moving vehicle, a driver needs to perform three actions:

- **See** - a hazard
- **Think** - decide to stop
- **Do** - place foot on the brake pedal until vehicle stops

The function of any braking system is to slow the motion of a moving vehicle. Heavy commercial vehicles take more time and more distance to stop than smaller vehicles. More braking force is needed to overcome their weight and forward motion.

The distance a commercial vehicle needs to stop is affected by the following four factors:

- **Brake condition.** All the brakes on a vehicle must share the task in the same way. If one or more brakes are not properly aligned or maintained, the remaining brakes will have to generate more friction. This means that it will take longer to stop the vehicle.
- 1 Traction.** Traction is the friction between the road surface and the area where the tire contacts that surface. The amount of traction a vehicle has depends on:
    - the condition of the road
    - how much tire contact there is with the road surface

- the condition and inflation pressure of the tires
- the gross vehicle weight (GVW) of the vehicle

The more traction the vehicle has, the less time and distance it will take to stop. There is the most traction just before all the wheels lock up. There is less traction when the wheels are skidding.

- 2 Weight (GVW).** A heavy vehicle, even though it has better traction, needs more time and distance to stop. When the weight is doubled, the amount of force needed to stop the vehicle is doubled, and it will take about twice as long for that vehicle to stop (Figure 1 - page 42).
- 3 Speed.** The greater the speed, the more time and distance are needed to stop. Figure 2 illustrates that doubling the vehicle speed means that four times the braking force is required to bring the vehicle to a stop. Figure 3 illustrates that if both the speed and weight are doubled, the amount of force required to stop the vehicle will be increased by eight times.

## Stopping distance

The total stopping distance to bring a vehicle to a complete stop is measured from the time a driver realizes the need to apply the brakes until the vehicle comes to a full stop. The time it takes for a vehicle to stop is affected by four factors:

- 1 Perception time** is the amount of time it takes a person to realize the need to stop the vehicle. The average perception time is about three-quarters of a second. Perception time can increase if a person is not paying

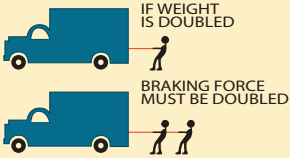

Figure 1

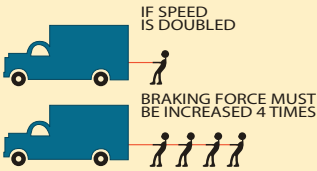
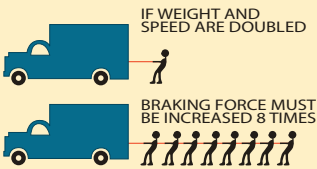

Figure 2



attention to driving, or is not feeling well physically or mentally. Perception distance is how far a vehicle travels during this time.

**2 Driver reaction time** is the amount of time it takes between deciding to stop and actually applying pressure to the brake pedal. Normal driver reaction time is about three quarters of a second. Reaction time will be slower if the driver:

- is tired, or
- has been drinking alcohol or using drugs

Reaction distance is how far a vehicle travels during this time.

**3 Lag time** is the amount of time it takes for the air brake system to respond after the driver has applied pressure on the brake pedal. Air brakes do not respond immediately because it takes time for the compressed air to flow through the system and apply the brakes which takes about 4/10 of a second. Lag time distance is how far a vehicle travels during this time.

**4 Braking time** is the amount of time it takes for the vehicle to come to a complete stop after the brakes have been applied. Braking time depends on:

- the force with which the brakes are applied
- the condition of the brake linings and drums
- the traction of the tires on the road surface
- the vehicle weight and speed

Braking distance is how far a vehicle travels during this time.

**Total stopping distance is the sum of perception distance, reaction distance, lag time distance and braking distance.**

Another factor involved in stopping distances is the slope or grade of the road. A vehicle travelling down a hill will need a longer stopping distance than a vehicle travelling at the same speed on a level surface because of the effect of gravity. A vehicle travelling up a hill will stop in a shorter distance than a vehicle travelling the same speed on a level surface, again because of the effect of the grade.

## General braking information

- When applying the brakes, press down the pedal using an even pressure and then ease off the pedal as the vehicle slows down. Just before the stop, release the brakes to avoid a sudden jerk or rebound. Then apply pressure to the brake pedal again to hold the vehicle while it is stopped.
- Do not pump (alternately applying and then releasing) the air brakes as this will

result in a loss of air pressure. Pumping the brakes on a long downhill grade may mean that you do not have enough air pressure for the brakes to work properly.

- Avoid using the brakes too much going down hills. Downshift before going over the top of the hill. Use engine compression as a way to control your speed on steep grades.
- If there is a low air pressure warning, stop as soon as possible in a safe place. Increase the air pressure before continuing.
- Before going down a hill, test the brakes. Look at the air pressure gauge, apply the brakes, and check for abnormal air pressure loss. Do not proceed if there is abnormal pressure loss.
- If the trailer hand valve is used too much, particularly on steep hills, the trailer brakes may fail. Use of the trailer hand valve only is not recommended as it leads to a greater wear on the trailer brakes than the truck-tractor brakes. This causes unbalanced braking between the truck-tractor and the trailer which could cause the unit to jackknife.
- Always be sure the brakes are adjusted properly. If they are not, some brakes will have to work harder than the others. This could cause a skid.
- A driver must not pull any trailer that weighs more than 2,300 kg that is not equipped with brakes controlled by the driver.

## Coupling and uncoupling a truck-tractor and semi-trailer

### Coupling

The basic steps for coupling a truck-tractor to a semi-trailer are as follows:

- Chock the semi-trailer wheel. If you only have one chock, place it to the rear of the semi-trailer wheel. If you have two chocks, place one to the front and one to rear of the semi-trailer wheel.
- Check that the jaws on the fifth wheel are in the unlocked (open) position.
- Check the condition of the semi-trailer apron, king pin and it's collar for excessive wear or cracks.
- Back the truck-tractor in line for the hook-up with the semi-trailer. Stop before contact is made between the fifth wheel and the trailer apron.
- Check that the height of the fifth wheel and the semi-trailer match.

**NOTE:** *Some older trailers may not have spring brakes.*

- If the semi-trailer does have spring brakes on at least one axle, connect air lines from the truck-tractor to the semi-trailer and fill the trailer air tanks.
- Set the semi-trailer brakes.
- Back the truck-tractor until a connection has been made.
- Perform a firm tug test to ensure you have a good hook-up. If noticeable slack is present, make necessary corrections.
- Visually check that the fifth wheel jaws are properly locked around the trailer king pin.
- Raise the landing gear and hook-up the electrical line.
- Remove wheel chocks.



## Uncoupling

The basic steps for uncoupling a truck-tractor from a semi-trailer are as follows:

- ❑ Park the truck-tractor and semi-trailer in a straight line and set the park brakes.
- ❑ Chock semi-trailer wheel. If you only have one chock, place it to the front of the semi-trailer wheel. If you have two chocks, place one to the front and one to the rear of the semi-trailer wheel.
- ❑ Lower the landing gear.
- ❑ Disconnect the electrical and air lines and unlock the fifth wheel.
- ❑ Secure the electrical connection and air lines to the truck-tractor.
- ❑ Move the truck-tractor ahead slowly until the fifth wheel just clears the semi-trailer and stop.
- ❑ Check that the ground and landing gear support the semi-trailer.
- ❑ Move the truck-tractor ahead slowly until the tractor frame completely clears the semi-trailer.

## Coupling and uncoupling pintle hitch attachments

The Basic Steps In Uncoupling Pintle Hitch Attachments Are:

- ❑ Park the towing/power unit and trailer in a straight line.
- ❑ Set the parking brakes of the towing/power unit and trailer.
- ❑ Chock trailer wheels.
- ❑ Disconnect air lines, electrical line and other associated hoses (if applicable).
- ❑ Disconnect safety cables/chains from towing/power unit.
- ❑ Disconnect safety pin (if equipped).
- ❑ Release pintle hook locking (safety latch) mechanism.

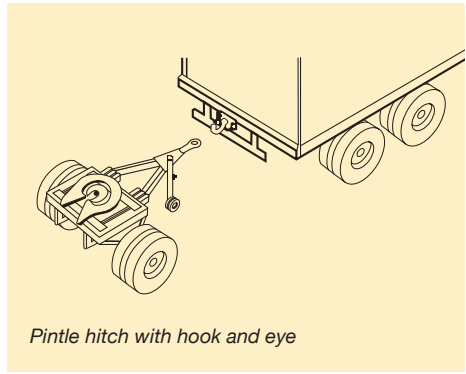

*Pintle hitch with hook and eye*

- ❑ Lower landing leg if equipped; otherwise, block the drawbar when required.
- ❑ Move towing/power unit ahead slowly until pintle eye completely clears pintle hook.
- ❑ Stop and visually check that the pintle eye is free of the pintle hook.

The Basic Steps In Coupling Pintle Hitch Attachments Are:

- ❑ Position the towing/power unit in line to receive the pintle eye.
- ❑ Stop the towing/power unit before contact is made with the pintle eye.
- ❑ Chock trailer wheels.
- ❑ Ensure pintle hook is open to receive pintle eye.
- ❑ Ensure pintle hook and eye has no cracks and or signs of excessive wear.
- ❑ Ensure pintle eye is the proper height to lower onto the pintle hook, adjust drawbar height if necessary.
- ❑ Position towing/power unit so the pintle eye can be lowered onto the pintle hook.
- ❑ Snap pintle hook shut and ensure safety latch is locked.
- ❑ Properly attach safety cables/chains to towing/power unit.
- ❑ Fasten safety pin (if applicable).

- ❑ Properly attach air lines, electrical line and other associated hoses (if applicable).
- ❑ Charge air system and if equipped with a “no-slack ram”, do a tug test to ensure the ram is energized.
- ❑ Perform a visual inspection to ensure all locking mechanisms are properly secured.
- ❑ Place landing leg (if applicable) in transport position and remove chocks.
- ❑ Ensure hitching devices are secure and re-check safety latch.

The most important task in the coupling procedure is to physically and visually check all connections. Failure to do so may be the cause of a serious incident.

## Coupling mechanisms

### Double trailer combination types

When adding a second trailer to the rear of a lead trailer, a converter mechanism is needed. Each converter must have its own fifth wheel attachment. There are three different types of converters.

#### A TRAIN

This converter has an A shaped drawbar that joins into a single pintle hitch point on the lead trailer. Due to its A shape, it is often called an A-dolly. When two trailers are joined together using the A-dolly, the whole unit is called an A train. These converters provide two points of articulation (joints that allow side to side or lateral movement). One of these points is at the pintle and the other is at the fifth wheel.

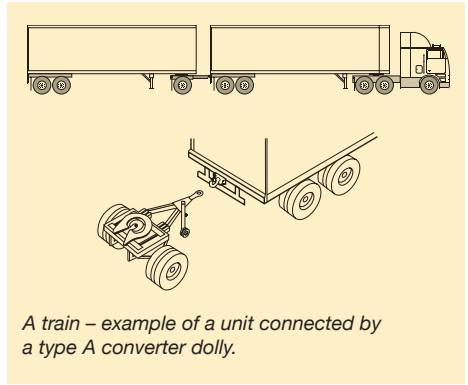

#### B TRAIN

In a B train, the converter is part of the lead trailer. The fifth wheel assembly sits on the rear axle of the lead trailer. It is either permanently fixed in position or slides out with the rear axle.

No converter dolly is required, as the second unit connects directly to the extended frame of the lead unit.

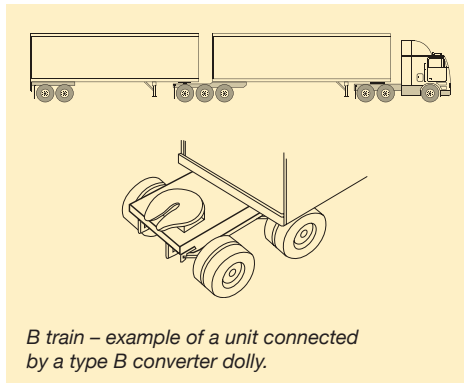

#### C TRAIN

A C train is like the A train, in that it uses an independent converter. The difference between the two is that the C train has two drawbars and two pintle hitches in the double drawbar converter.

Two bars mean there is only one articulation point. The result is that the trailer moves less from side-to-side. To improve performance even more, double drawbar converters have a self-steering axle.

When driving a C train, check that the air pressure on the self-steering axle is within the manufacturer's standards. If the air pressure falls too low, the wheels will steer too much and the unit becomes unstable. This can lead to skid steering, which can damage the converter and hitch.

## EXAMPLES OF LONG COMBINATION VEHICLES

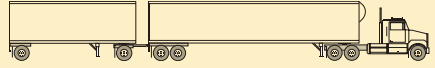

*Rocky Mountain Double*

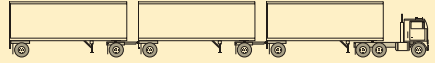

*Triple*

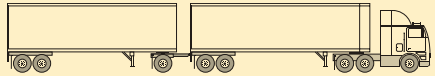

*Turnpike Double*

## Operating long combination vehicles

When a permit is issued according to Section 62 of the *Traffic Safety Act* authorizing the movement of Long Combination Vehicles (LCVs), a list of general provisions must be followed. Some of these provisions are listed below.

**NOTE:** For a complete, current list of all provisions, carriers who wish to operate LCVs should contact the Transport Engineering Branch at (403) 340-5189. For toll-free service from anywhere in Alberta, call 310-0000.

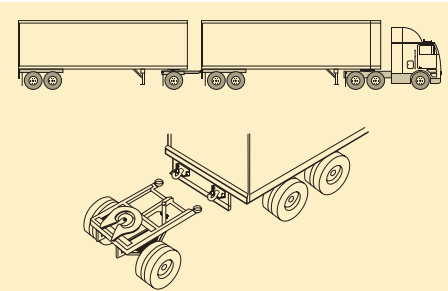

*C train – example of a unit connected by a type C converter dolly.*

## Link-up arrangement

When linking two or more trailers to a towing unit, always hook the heaviest trailer directly to the tractor. The lightest trailer should be the furthest away from the towing unit. This rule applies no matter how long each trailer is. If the trailers are not joined according to weight, the unit will be unstable. The rear trailer will sway and control of the unit could be lost.

- Companies must have and be able to provide proof that their drivers and driver trainers meet and maintain the requirements outlined in the Canadian Trucking Alliance's *Longer Combination Vehicle Driver's and/or Instructor's Manual*.
- The carrier is responsible for issuing an annual LCV Driver's Certificate. The Driver's Certificate is valid for 12 months after the date of issue, and must be in the possession of the driver at all times when operating an LCV. Before issuing an LCV Driver's Certificate, the carrier must ensure that the driver meets the following qualifications. The driver:
  - holds a valid Class 1 driver's licence or equivalent
  - has passed a recognized air brake course
  - has a minimum of 24 months or 150,000 kilometres of driving experience with articulated vehicles in the Class one category
  - has passed a Professional Driver Improvement Course (PDIC) within the past 48 months
  - has passed the Canadian Trucking Alliance's Longer Combination Vehicles Driver Training Course or equivalent
  - has a driver's abstract that is dated not more than one month prior to the issue date of the Driver's Certificate. It must show no driving-related criminal code convictions in the prior 36 months; no more than two moving violations in the prior 12 months; and no more than three moving violations in the prior 36 months. The date of conviction and the current date are the dates used to determine the time periods.
    - has in the past 12 months been instructed on all current regulations, permit conditions and issues covering the operation of LCVs.

## SPEED LIMITS FOR LONG COMBINATION VEHICLES

The maximum speed limit for drivers of long combination vehicles shall not be more than 100 km/h or the posted speed limit, whichever is lower.

## Driving skills and manoeuvres

### Following distance between vehicles

Remember that the two-second rule is the minimum following distance for passenger vehicles and is accurate at any speed. When operating a large vehicle, use the **four-second** rule to determine a safe following distance. Watch the vehicle ahead pass a fixed object, like a telephone post, and start to count one-thousand-and-one, one-thousand-and-two, and so on. If you reach the object before counting to one-thousand-and-four, you are following too closely. You must slow down to increase the distance between your vehicle and the vehicle ahead.

Double and triple trailer units take up more space than other commercial vehicles. They are not only longer, but also need more space because they cannot turn or stop as quickly. Allow more following distance. Make sure the gaps are large enough before entering or crossing traffic. Be certain you are clear at the sides before changing lanes. When weather,

road or traffic conditions are poor, **double your following distance.**

## Off-tracking

In any vehicle where the rear axle cannot steer during a turn, the rear tires will follow a different path than the steering tires. This is called off-tracking. There are two types of off-tracking:

- 1 Low speed off-tracking is common when driving in a city. In low or moderate speed turns, the rear tires are pulled inward of the steering path. The longer the wheelbase of the vehicle or the tighter the turn, the more off-tracking occurs.
- 2 High speed off-tracking is the effect of centrifugal (outward) force. It is seen when a vehicle travels at higher speeds, and the rear tires pull outward from the steering path during a turn. When you are driving a large vehicle, use a moderate speed when entering curves on open highways. Otherwise, you may encounter serious high-speed off-tracking that may result in a dangerous situation.

## Turns

It takes different skills and knowledge to turn a large vehicle compared to turning a passenger vehicle. To start, have a look at the general turn rules that are explained in the *Driver's Guide to Operation, Safety and Licensing* book. Remember the off-tracking tendencies of the large vehicle, and that it has a wider turning radius. The hand-over-hand steering method is recommended. Always use both hands to steer the vehicle. Select the appropriate gear before starting the turn unless the vehicle has an automatic transmission.

## RIGHT TURNS

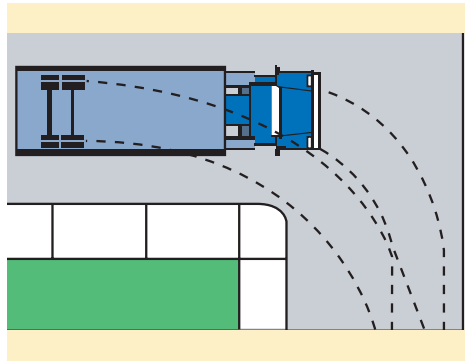

Be aware that, for every turn of the steering wheel, the rear wheels will follow a shorter path than the front wheels. Allow for this low speed off-tracking on every turn. Otherwise, your vehicle could hit another vehicle, or stationary object, or run over a curb and hit a pedestrian.

If the street is narrow, drive well into the intersection before starting the turn. You might need to go over the centre line of the street you are entering or into the second traffic lane. Whenever making a turn, be cautious and ensure it can be done safely.

Look for smaller vehicles and cyclists that may try to pull along the right side of your tractor-trailer during the turn.

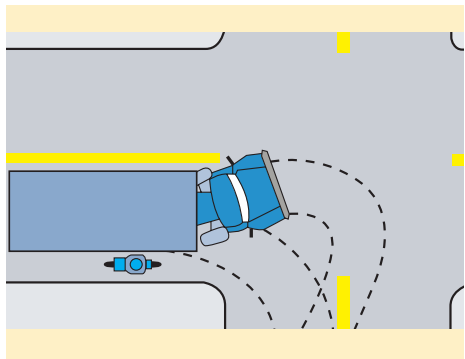

## LEFT TURNS

When turning left, ensure your vehicle's

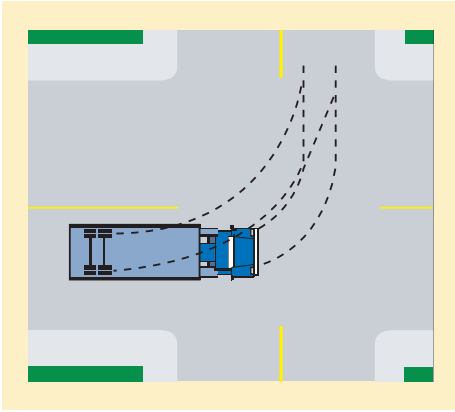

turning arc is wide enough to allow the vehicle to off-track on the left side without crossing the centre line. Your turn must be wide enough to prevent the vehicle from cutting the corner and hitting another vehicle. Complete the turn by driving to the right side of the centre line of the road entered.

## Curves

Enter a curve at a speed that does not require braking, but does allow you to gradually accelerate while in the curve.

When entering a curve, centrifugal force acts on the vehicle. This force pushes the vehicle towards the outside of the curve.

Traction resists centrifugal force. The amount of traction your wheels have with the road's surface determines the amount of control that can be maintained over the vehicle.

When speed is increased, both momentum and centrifugal force are greater. When entering a curve too quickly, these forces may be greater than the traction that is present. This can cause

a loss of control of the vehicle. If you are travelling at too great a speed and try to slow down by applying the brakes, this may cause the vehicle to skid, roll over or jackknife.

## RIGHT CURVES

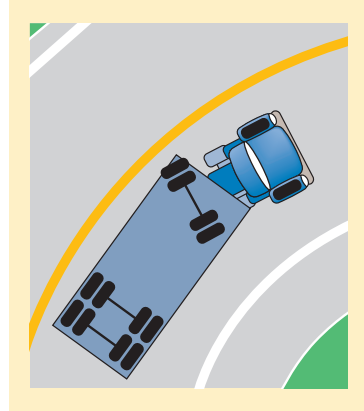

Keep the front of the vehicle closer to the centre of the road so the trailer wheels do not roll over the curb or drop off the pavement on the right.

## LEFT CURVES

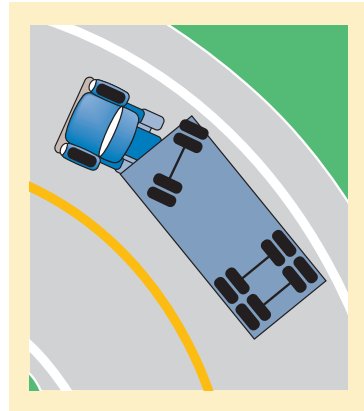

Keep the front of the vehicle closer to the outside of the curve (right side of road) so the trailer wheels do not cut into the other lane of traffic on the left.

## Parking

Always select a safe place to park the vehicle. Set the parking brake in the tractor. Do not use the trailer hand valve to hold a parked unit. Put the transmission in the lowest forward or reverse gear (if applicable). If the vehicle has a two-speed axle, put the axle in low range.

Properly block the wheels using wheel chocks. The minimum size for square blocks should be 15 centimetres by 15 centimetres.

Do not expect the transmission to do the work of securing the vehicle. Always use the vehicle's parking brake system and wheel blocks.

### PARKING ON A HILL

The law requires that the wheels of a parked vehicle be no more than 50 centimetres from the curb. When parked, the vehicle must be left in low gear or reverse for a manual transmission or park for an automatic transmission. Have the park brake engaged. The following information applies to vehicles parked on the right-hand side of the road. For vehicles parked on the left-hand side of the road (one-way), turn the front wheels in the opposite direction.

- For parking downhill, with or without a curb, the front wheels should always be turned to the right.
- For parking uphill with a curb, the front wheels should always be turned to the left.
- For parking uphill without a curb, tractor-trailer units with one articulation point should always have the front wheels turned to the left.

**NOTE:** *If there is a curb, allow the vehicle to roll to the point where the front wheels are making contact with the curb before setting the park brake. This helps to prevent the vehicle from jumping the curb if the vehicle starts to move.*

## Reversing

- When reversing a semi-trailer, turn the steering wheel in the opposite direction to where you want the trailer to go. Another method is to place your hand on the bottom of the steering wheel and move your hand in the same direction that you want the trailer to go. The tractor must follow an S-shape in order to bring the trailer around smoothly.
- Always reverse the vehicle slowly and use both the rear view mirrors. Never forget that there is always a blind spot directly behind the vehicle that is not visible in the mirrors.
- Avoid unnecessary reversing by planning ahead.
- Sound the horn as a safety precaution before reversing. Repeat at least once for every vehicle length reversed.
- If possible, ask someone to act as a guide and establish hand signals between the driver and the guide. The guide must be able to see the path the vehicle is taking. The driver must be able to see the guide. Stop if you cannot see the guide.
- Remember that even with a guide, the driver is still responsible for all movements of the vehicle.

## STRAIGHT LINE REVERSING

Straight line is the easiest and safest form of reversing. Reverse straight whenever possible. Normally you will have a clear view in both mirrors of the space that you are reversing into.



- If it is not possible to have a guide, always check the area where you are reversing before beginning the move. Get out of the vehicle, walk behind it and visually check the area. Look for obstructions and clearance.
- If the reversing distance exceeds two vehicle lengths, stop, get out and visually recheck the areas behind, above, below and around the entire unit.
- Keep your foot off the throttle. You will rarely need to use it to start your unit reversing. Always select the lowest reverse gear available. Move very slowly and keep your right foot covering the brake pedal in case you need to stop quickly.

Here are some examples of hand signals.

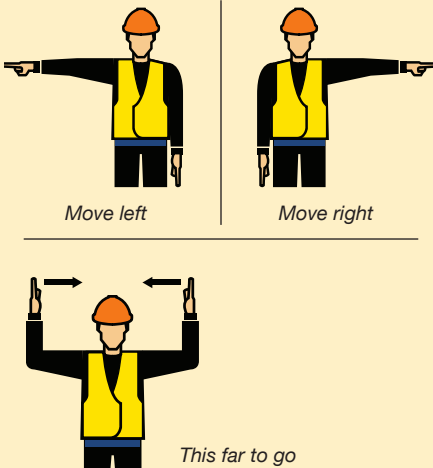

## 90 DEGREE REVERSING, CLEAR SIDE (LEFT SIDE)

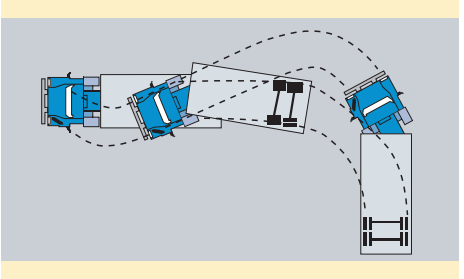

Reversing to the left provides a clear view in the left mirror of the space you are reversing into.

Start reversing and turn the steering wheel to the right to move the trailer to the left. Once the trailer is curving towards the space, turn the steering wheel to the left and let the tractor follow the trailer into the space.

When the trailer is in line with the parking space, turn the steering wheel even more to the left to straighten the tractor in relation to the trailer. Slowly finish reversing into the loading dock or parking space.

## 90 DEGREE REVERSING, BLIND SIDE (RIGHT SIDE)

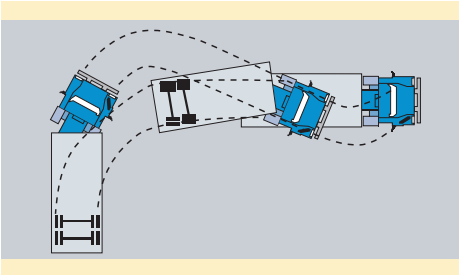



Reversing from the blind side uses the same steps as clear side reversing. However, it is harder to see where you are going. Once the reversing has started, you will mostly be using the right side mirror, including the convex mirror.

You should stop often and get out of the tractor to check your position.

This type of reversing is the most difficult and also potentially the most dangerous. Avoid it if you can.

## Important information for commercial drivers

- When carrying logs on a vehicle, the overhanging logs may swing across the other traffic lanes when you turn. Try to let traffic behind pass before you make the turn.
- If a breakdown occurs on the highway, park the vehicle as soon as possible, in a safe position on the right side of the roadway.
- If the breakdown occurs on a highway, outside the limits of an urban municipality between sunrise and sunset (during the day), activate the emergency hazard lights. Place an approved warning device on the highway in line with the vehicle about 30 metres (about 100 feet) in both front and reverse of the vehicle.
- If the breakdown occurs on a highway, outside the limits of an urban municipality between sunset and sunrise (in darkness), or anytime when there is not enough light to clearly see people or vehicles on a highway at a

distance of 150 metres, activate the emergency hazard lights. Place an approved warning device 75 metres (about 250 feet) in front of and behind the vehicle.

- If your truck is carrying explosives or flammable goods, you must stop before every uncontrolled railway crossing.
- When driving in urban areas (cities and towns), you must drive only on the routes specified for trucks and dangerous goods vehicles.
- If driving a vehicle that carries dangerous goods, you must comply with the federal and provincial laws describing how dangerous goods should be handled, stored and transported.

If a vehicle's load reaches or extends more than 1.5 metres beyond the rear of the vehicle, the following is required:

- During daylight hours, a red flag, not less than 30 centimetres square, must be attached to the end of the extension.
- During nighttime hours, a red light must be attached to the end of the extension.

**NOTE:** *If your truck or vehicle is carrying goods or commodities to the United States, and this is not something you do on a regular scheduled basis, you must contact either the Department of Transportation or the Department of Highways **in each state** where you will be travelling before starting your trip. Each state has different laws. Your trip will be faster and smoother if you obtain all the proper permits and documents before you go.*

5

# Operating Class 2 Vehicles

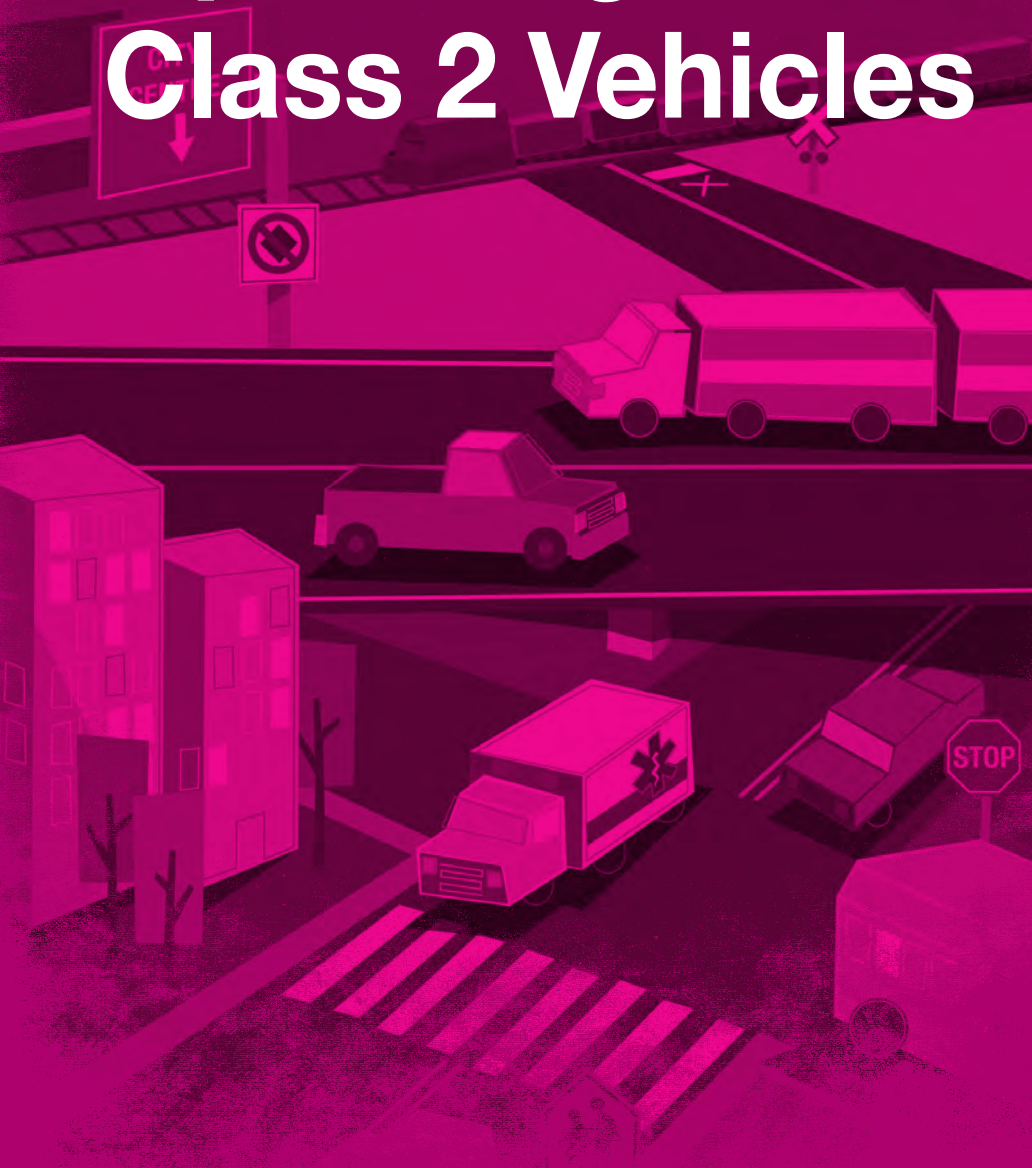



## Information for class 2 and class 4 bus operators

While the following information may apply to various types of buses, it is primarily about the operation of school buses. If you drive a bus, even if it is not a school bus, you should still read this section carefully. Most of the facts and procedures that follow apply to all bus operations.

As a bus operator you are responsible for the safe transportation of a large number of passengers, regardless of weather, road or traffic conditions experienced during the trip. That responsibility exists whether the bus you drive is a commercial, school or private bus. You must have the skills to adjust quickly to changing conditions both inside and outside the bus.

Know all the rules and regulations under which you operate, including company policy.

## Operating a school bus safely

### School bus breakdowns

Even if a walk-around of the bus is done daily and a regular maintenance schedule is followed, the bus may break down when you least expect it. If this happens on the road, do the following:

- If possible, stop the bus in a safe place as far off the roadway as practical.
- Analyze the situation. If the bus is stopped in a dangerous location, get the passengers off the bus and guide them to a safe location. If there is no danger, it is usually safer if the passengers stay on the bus.
- If a breakdown occurs, and the vehicle is stationary on a highway outside the limits of an urban municipality during the period between sunrise and sunset (during the day), activate the emergency hazard lights. Place an approved

warning device 30 metres (about 100 feet) in front of and behind the bus.

- If a breakdown occurs, and the vehicle is stationary on a highway outside the limits of an urban municipality during the period between sunset and sunrise (in darkness), or anytime when there is not sufficient light to see people or vehicles clearly on a highway at a distance of 150 metres (about 492 feet), activate the emergency hazard lights. Place an approved warning device 75 metres (about 250 feet) in front of and behind the bus.
- If you cannot fix the problem quickly or cannot radio or phone for help, stay with the bus.

## Left / right turns

When turning left or right at an intersection do the following:

- Prepare well in advance by positioning the bus in the appropriate lane depending on the direction of travel.
- Give the proper turn signal in sufficient time to provide a reasonable warning to other motorists of your intention.
- Reduce your speed and downshift to the proper gear needed to execute the turn.
- Check traffic and conditions to your left and right then left again before making your turn. Watch for both vehicle and pedestrian traffic.
- Check for traffic signals or signs that are directed to you plus be aware of signs or signals that apply to cross-traffic.
- Executing the turn
  - Turning left – take the left most lane available (unless directed otherwise by arrows on a traffic sign or markings on the road surface). If

stopped waiting to turn, keep the front wheels pointed straight and the break pedal depressed to ensure your brake lights are on and if struck from behind your bus will not be pushed into oncoming traffic. When turning left off a two-lane highway, make a quick shoulder and mirror check to ensure you are not about to be passed by an overtaking vehicle.

- Turning right – take the right-most lane available.
- On dual left turn lanes, it is preferable to use the outer left turning lane.
- Never shift gears during the turn.
- Check the left and right mirrors as you are turning for bus body swing and clearance.
- Check that your turn signal has been cancelled once the turn is complete.

## Reversing

Reversing a school bus is a leading cause of school bus collisions. It should be avoided whenever possible. It is illegal to reverse a loaded or unloaded school bus in a schoolyard or at a location next to a school ground unless there is a responsible guide located outside at the rear of the bus giving direction. Remember that you are responsible for all movements of the bus. Here are some guidelines to follow.

- Physically check the area for any obstructions and clearances.
- Have a responsible adult act as a guide.
- Agree on the hand signals that will be used.
- Tell the person where to stand.
- Tap the horn.
- Reverse slowly.
- Stop immediately if you lose sight of the guide.

Remember, even with a guide, you are still responsible for all movements of the bus.

When required to reverse, other than on school property, make sure the area is clear of obstructions and use both side mirrors.

## Turnarounds

Some bus routes may require a driver to do a turnaround. The only time a turnaround should ever be done on a two-lane highway is if it cannot be done on private property. Turnarounds are done by backing into a road on the right of the main roadway. Never back onto or across a highway. When a turnaround must be done, the following procedure is recommended:

- Start slowing down well in advance of the turnaround.
- Stop the bus in the proper position on the main roadway. It should be about one bus length ahead of the road that you will be reversing into. Check traffic in all directions to ensure that there is enough time and space in the traffic to allow the turnaround. Wait for traffic to pass around you.
- Back into the road on the right when it is clear, using your mirrors and shoulder checking to the right.
- Re-enter the main roadway when it is clear and safe to do so.

**Remember, never back onto or across a highway.**

If required to load or unload passengers at the turnaround point, do the following:

- Load the passengers **before** the turnaround (see 1 and 2 on the diagram).
- Unload the passengers **after** backing (see 3 and 4 on the diagram).

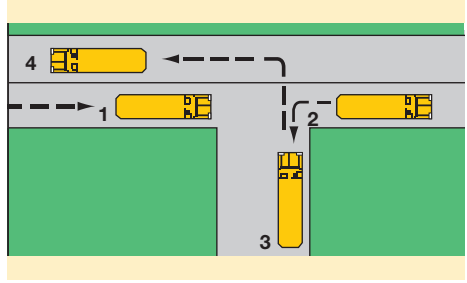

A U-turn can be done on a four-lane divided highway if the length of the bus is less than the width of the median separating the flow of traffic.

The bus must be brought to a full stop on the crossroad. The front and back of the bus must be clear of all traffic lanes.

## Passenger loading and unloading

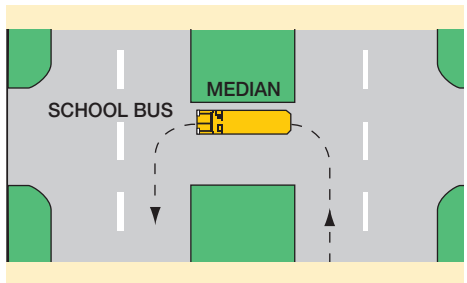

School bus operators should follow these procedures:

- The law requires that the alternately flashing red lights and stop arm **only** be used when loading and unloading passengers. The driver must know when the alternately flashing lights must be used. Local authorities may prohibit

or restrict their use. **All drivers must activate the alternately flashing lights when loading and unloading passengers, except when operating on a roadway where a bylaw prohibits their use.**

- Drivers of vehicles must stop when approaching a stopped school bus displaying alternately flashing red lights from either direction on an undivided highway, and from behind the bus on a divided highway.
- On buses equipped with the eight-light system, the alternately flashing amber lights shall be activated as the bus begins to slow down for the stop. Where possible, minimize traffic disruption by allowing vehicles to pass before turning on the alternately flashing red lights.
- Pull as far to the right as practical before stopping to load or unload passengers. Choose a location that allows safe footing and is at least one metre away from the students waiting to board. The law allows a driver to stop on the roadway if a suitable and safe location off the roadway is not available.
- Activate the alternately flashing red lights when the bus comes to a complete stop. The alternately flashing lights must not be used when the bus is not involved in loading or unloading passengers.
- Before loading or unloading, check that all traffic has stopped, that the transmission is in neutral for a manual transmission, or park for an automatic and the park brake is applied. Keep firm pressure on the brake pedal.
- Open the door of the bus and let the passengers on or off.

- If students must cross the highway in a rural area after getting off the bus, instruct them to go at least 10 paces in front of the bus, stop before they enter the roadway and wait for your direction before crossing the road. Establish a line of sight with them; look up and down the roadway checking for traffic before you let them cross in front of the bus. Do not lose sight of the students as they cross and be sure that you can account for all of them.
- Before moving, check all mirrors, including the cross over mirror, to ensure that no students are lingering near the bus.
- Turn off the alternately flashing lights after all the students are seated, release the park brake, and when it is safe signal left and re-enter the traffic flow.

Drivers must also be aware of the following:

- The bus must not be moving while students enter or exit.
- It is against the law to back a school bus in a schoolyard without guidance from a responsible person located outside and at the rear of the bus. You must be able to see the guide at all times. You are responsible for all your movements.
- Be sure that all the students are seated while the bus is in motion.
- Never exceed the seating capacity of the bus.
- Always use frequent mirror checks to be sure that it is safe before activating the alternately flashing red lights or giving a signal for the students to cross the roadway. Even though other drivers are required by law to stop, they may not.

- If a driver of a vehicle does not stop for the alternately flashing red lights, write down the vehicle's licence plate number and report the incident immediately to the local police authority and your supervisor.

## Parking on a hill

The law requires that the wheels of a parked vehicle be no more than 50 centimetres (about 19 inches) from the curb. When parked, the vehicle must be left in low gear or reverse for a manual transmission or neutral for an automatic transmission. Have the park brake engaged. The following information applies to vehicles parked on the right-hand side of the road. (For vehicles parked on the left-hand side of the road, turn the front wheels in the opposite direction):

- For parking downhill, with or without a curb, the front wheels should always be turned to the right.
- For parking uphill with a curb, the front wheels should always be turned to the left.
- For parking uphill without a curb, single unit vehicles should always have their front wheels turned to the right.

**NOTE:** *If there is a curb, allow the vehicle to roll to the point where the front wheels are making contact with the curb before setting the park brake. This helps to prevent the vehicle from jumping the curb if the vehicle starts to move.*

## Railway crossing procedures

Railway crossings present a special hazard because any time is train time. Know the railway crossing laws and school board policy, as well as municipal bylaws.

As a driver of a school bus, you are required by law to stop at a railway crossing unless:

- the crossing has a traffic control signal, lights and bell, or
- a peace officer or flagman directs you to proceed.

The following procedures apply at all uncontrolled railway crossings:

- There should be no excess noise from the bus. Turn off any fans or radio that are working and ask the passengers to be quiet.
- If in the left lane of a multi-lane highway, signal and change to the far right lane well in advance of the crossing.
- Check for traffic behind. The alternately flashing amber or red lights must not be used when stopping at a railway crossing.
- Stop not less than five metres (about 16 feet) or more than 15 metres (about 49 feet) from the nearest track.
- Put a manual transmission in neutral or park. For an automatic transmission, engage the parking brake and keep firm pressure on the brake pedal.
- Open the front door and the driver's window. Look both ways and listen for an approaching train. If you see or hear a warning signal or train whistle and do not see a train coming, do not cross the tracks until you know it is safe to do so. If bright sunlight, fog, snow or smoke makes it hard to see, walk to the track to see if you can cross it safely.



- Remember, as the driver of the school bus, you must never leave the bus without turning off the engine, setting the brakes, putting the transmission in its lowest gear (manual) or park (automatic) position and taking the key out.
- When you are sure that it is safe to proceed, select an appropriate low gear.
- Release the park brake.
- Check left and right.
- Close the door.
- Cross the tracks.
- If the transmission is manual, do not shift gears until you are clear of the last track.
- When following another vehicle, always allow enough of a space cushion. Use the **four-second** following rule and increase this distance when the road or weather conditions are poor or when it is difficult to see.
- Make sure all students are seated and remain seated while the bus is moving. Everyone must enter or leave the bus by the front door. The rear door, by law, should not be used unless there is an emergency. You and your passengers should know about the emergency exits, emergency equipment and evacuation procedures.

## Discipline and problem solving

- You are not only responsible for the safety of your passengers, but also for dealing with their behaviour while they are in the bus. Many discipline problems are also safety problems and should be handled quickly and efficiently. Remember, regardless of any problems that you may have with a student, you **cannot** unload the student at any place other than the student's normal destination. Only the school administration may remove or prohibit a student from riding a school bus.
- All doors must be closed when the bus is moving.
- When moving away from the curb, use caution, as you do not have the right-of-way.
- When crossing a highway, do not proceed until the traffic is clear in both directions.
- Never refuel a bus with passengers aboard.
- Establish a good relationship with your passengers. Your job will be easier and more enjoyable.
- At the beginning of the school year it is a good idea to hold an evacuation drill with everyone who rides the bus. This way, the passengers will know what to do in case of a real emergency. Hold the drill in a safe traffic-free area on, or next to the school property. Work with the school administration to set up the drill.

## Safe driving guidelines

- The maximum speed limit for a loaded or unloaded school bus, under ideal conditions, is 90 km/h or the posted speed limit, whichever is lower.
- Do not try to make up lost time by travelling faster than is reasonable for road conditions or the law allows.
- There are three standard methods to evacuate the bus, although other ways can be used in extreme situations. The three methods are: the front exit, the rear exit and the front and rear exit at the same time. In a real situation, you



will need to assess the situation and choose the most appropriate method to exit.

- A person driving a school bus (a) shall activate the strobe lamp during adverse atmospheric and visibility conditions, including fog, blizzard and smoke, and (b) may activate the strobe lamp where increased visibility is desirable.

6

# Operating Class 3 Vehicles

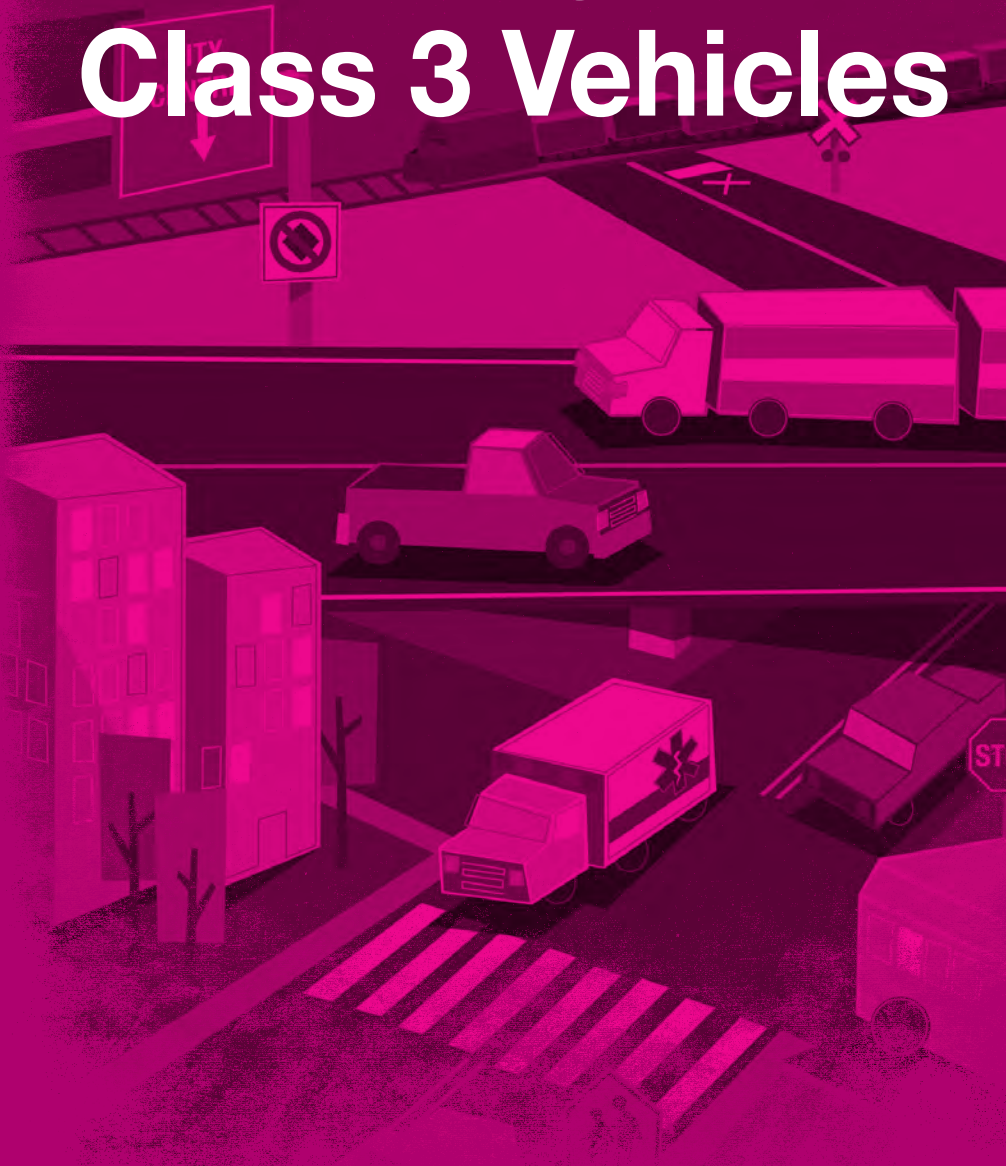

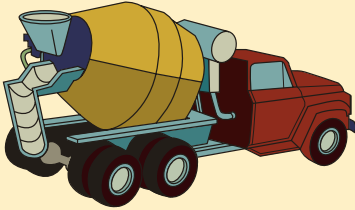
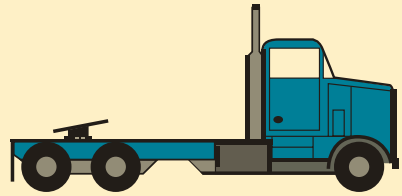
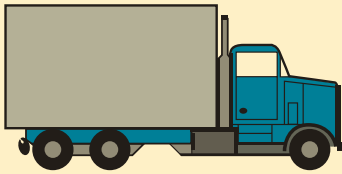

Examples of Class 3 motor vehicles are trucks designed for transporting goods or carrying loads.

## Loading and unloading dump vehicles

### Loading

Follow your company's policy for loading a vehicle on site. Some companies prefer drivers to remain inside the vehicle while others require them to stand outside the vehicle while it is being loaded.

When leaving the vehicle, use the three-point contact procedure. This means that two hands and one foot or two feet and one hand remain on the vehicle at all times. Never jump from the vehicle. When outside the vehicle, wear the appropriate protective equipment.

You must not move a loaded vehicle until the following has occurred:

- The material is evenly distributed in the box.
- The load is secured so it will not blow or fall off and damage other vehicles or cause personal injury. You must comply with the *Traffic Safety Act* when securing loads. If a municipality has a law that states that the load must be tarped, you must ensure that it is done. While covering the load, watch for debris that may have been caught in the tarp.
- The vehicle's tailgate, tailboards, doors, tarpaulins, spare tire and any other equipment that needs to be fastened is secured.
- There are no loose materials, debris or rocks in the tailgate, sides of the box, hitches or coupling devices. Clean or sweep off loose material with a brush or broom.

- The vehicle is loaded so the total dimensions and total weight on each axle are within the limits according to the laws in the jurisdiction where the vehicle is being operated.
- Remember, even with a guide, you are still responsible for all movements of the vehicle.
- Check for overhead wires and obstructions.
- Do not raise the box to dump unless the vehicle is on level ground.

## Before unloading

- Move slowly if you must back into a position to unload. Before backing in an unfamiliar area, get out, look around the area and walk the route that you will follow.
- You should back the vehicle to the driver's side (left) for better visibility. Use the mirrors continually to check your position.
- If the vehicle is equipped with a backing alarm, make sure it is working. Some regulations require a backing alarm when vehicles are around workers on foot. These alarms must be automatic and cannot have a shutoff switch as specified in *Occupational Health and Safety Code 2009*.

For more information regarding this code visit this web site; [http://www.employment.alberta.ca/documents/WHS/WHS-LEG\\_ohsc\\_2009.pdf](http://www.employment.alberta.ca/documents/WHS/WHS-LEG_ohsc_2009.pdf)

- Whenever possible, have someone guide the vehicle when you are unloading. Make sure that you and the guide use and understand the same hand signals. The guide should always be outside and to the rear of the vehicle so that he or she is able to see the path the vehicle is taking and be seen by the driver. The driver should always be able to see the guide. Stop if you cannot see the guide.

## During unloading

- Other vehicles and people must not be within the dumping radius of the raised box.
- Before dumping into a hopper, get out and look to make sure the hopper is empty.
- To avoid a tip-over, learn to recognize hazardous areas and situations. These include soft or uneven surfaces or poorly compacted fill.
- The tailgate chain and the angle of the truck bed will regulate how fast the material flows from the box.
- Check your operator's manual for detailed instructions for unloading.
- Release the tailgate. Be aware that a load that is concentrated at the rear of a raised box with the tailgate closed can tip the vehicle over backwards.
- Do not get into the raised box if the load is stuck. Lower the box first.
- If you lose sight of your guide, stop until visual contact is regained.
- Once the unloading has been completed, lower the box and ensure that the tailgate is latched.

## Mixer truck operators

Mixer trucks in the Class 3 vehicle category require the same basic procedures about pre-trip inspections noted in the previous section, except for the specific characteristics of that vehicle. Although loading and unloading the product would be different, similar safety precautions are needed, as well as the assessment of the conditions at each job site. The vehicle driver is responsible for the truck at all times.

Concrete mixers are top heavy and unstable when loaded. Due to the rotating action of the mixer drum and the unique characteristics of concrete, special care is needed when carrying low slump concrete on turns, corners and ramps.

## Parking on a hill

The law requires that the wheels of a parked vehicle be no more than 50 centimetres from the curb. When parked, a vehicle with a manual transmission must be left in low gear or reverse. For an automatic transmission put the vehicle in park and have the park brake engaged. The following information applies to vehicles parked on the right-hand side of the road. For vehicles parked on the left-hand side of the road (one way), turn the front wheels in the opposite direction.

- When parking downhill, with or without a curb, the front wheels should always be turned to the right.
- When parking uphill, with a curb, the front wheels should always be turned to the left.

- When parking uphill, without a curb, single unit vehicles should always have their front wheels turned to the right.

**NOTE:** *Where there is a curb, allow the vehicle to roll to the point where the front wheels are making contact with the curb before setting the park brake. This helps to prevent the vehicle from jumping the curb in the event the vehicle starts to move.*

7

# Operating Class 4 Vehicles

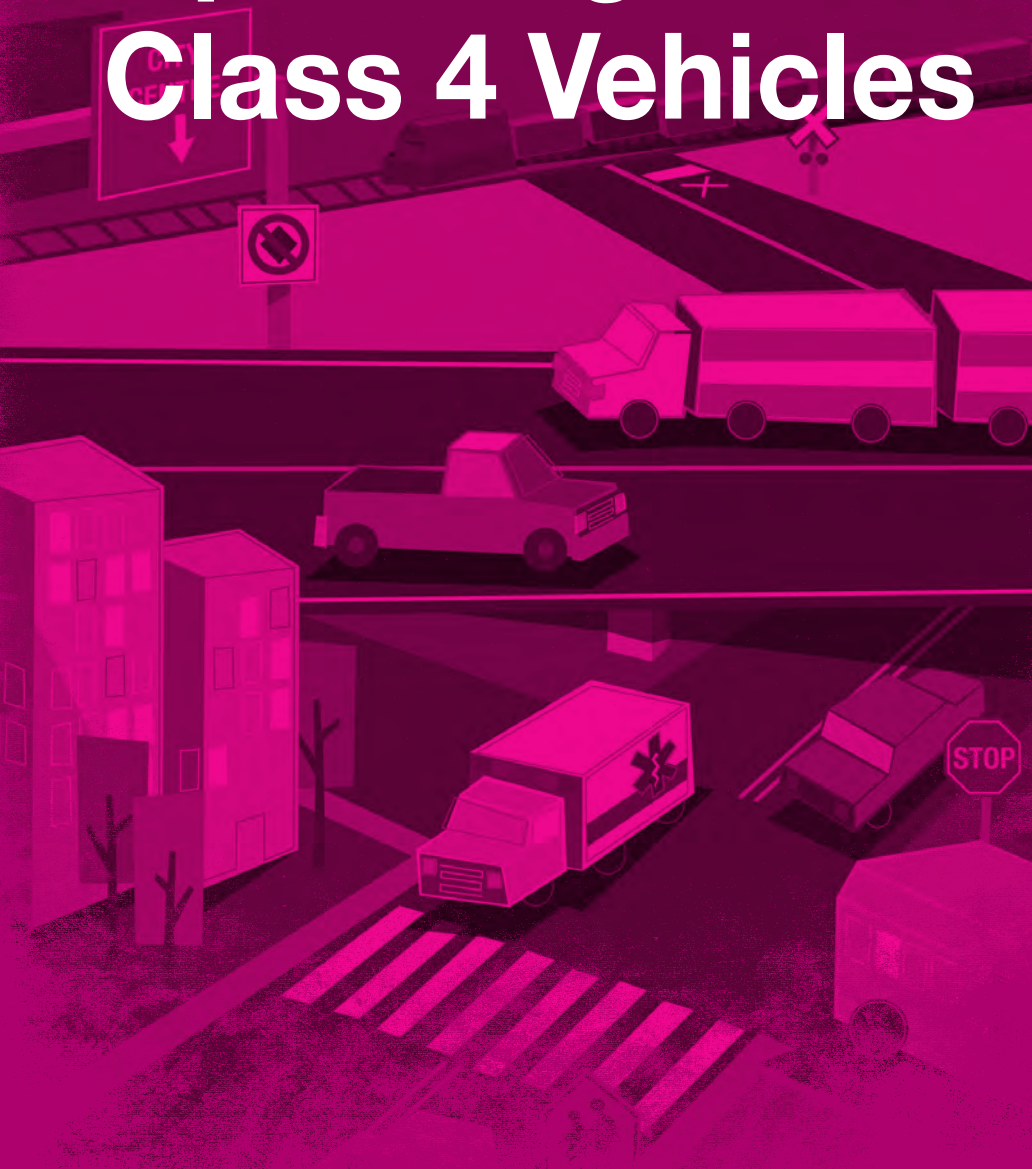



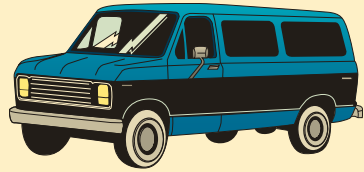
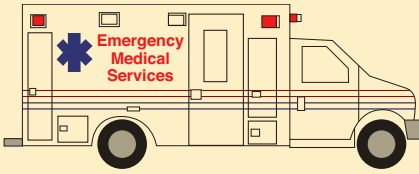

Examples of Class 4 motor vehicles are ambulances, taxis, buses with a seating capacity of less than 24 passengers, and vehicles being used for hire.

## Emergency vehicles

### Legal aspects of emergency vehicle operation

- The Traffic Safety Act, states that a siren on an emergency vehicle shall be operated only when the vehicle is being used in response to an emergency, an emergency call or an alarm.
- When operating an emergency vehicle, the law states:
  - (1) Where, considering the circumstances, it is reasonable and safe to do so, a person driving an emergency vehicle may while the vehicle's siren is operating do one or more of the following:
    - (a) drive the vehicle in excess of the speed limit;
    - (b) proceed past a traffic control signal indicating stop or a stop sign without stopping;
    - (c) contravene any provision that is prescribed by the Act, this or other regulations or a municipal bylaw governing the use of the highways.
  - (2) An emergency vehicle, while its siren is operating, has the right of way over all other vehicles.
- Use of the red flashing lights alone, does not exempt the driver from the *Traffic Safety Act*.
- The *Traffic Safety Act* authorizes emergency medical operators to disregard some traffic laws under limited circumstances. Failure to meet the requirements of these circumstances means that the driver may be subject to Civil and Criminal penalties in the event of a collision.

- Even during the most serious emergency, an emergency medical operator must consider the safety of others.
- When parking an emergency vehicle, the law states:
  - Where, considering the circumstances, it is reasonable and safe, an emergency vehicle may, while its flashing lights are operating, be parked contrary to any provision that is prescribed by the Act, this or other regulations or a municipal bylaw governing the parking of motor vehicles.

## Other factors

As an emergency medical operator, it is important to identify those situations that could result in a collision. Driving movements that can contribute to collisions are:

- reversing
- poor road position
- turning
- changing lanes
- lack of awareness of the unit size that can lead to side swipes on the blind right side
- driving too fast for conditions

## Defensive driving factors

### Headlights

Always use headlights along with the emergency overhead lights.

### Lights and sirens

Sirens are required by law when an ambulance is operating during an emergency. Using the red flashing overhead lights alone is not sufficient. Do not let the emergency sirens and lights give you a false sense of security. These warning devices are for the benefit of the public. Most drivers will clear the path if they know the ambulance is there. Do not assume that other drivers have seen your vehicle or that they will move out of the way. The responsibility for safe driving rests on you, the emergency vehicle driver.

If you approach an intersection with cross traffic, slow down and if practical, stop briefly. Make eye contact with the other drivers at the intersection and proceed when you have been seen by them. Be even more careful at pedestrian crossings. Many pedestrians, including school children, may not be aware that an ambulance is coming toward them.

If you are driving on a four-lane highway with the lights and siren activated, stay in the left lane if possible.

When reaching the scene of a collision, park the vehicle so it protects the injured person(s) and the attendant. Keep the flashing lights activated and turn on the headlights so that the vehicle is clearly visible to other drivers.

## Operating a taxi

As the driver of a taxi, your first and most important concern is safety. You will encounter numerous challenges in the driving task, and will need to be aware



of other road users and their driving. To handle this effectively, be patient and drive proactively. To help you focus on your driving, ensure that nothing in the vehicle, including the passengers, prevents you from doing your job. It is your responsibility to provide safe transportation to all your customers. However, you may refuse to transport customers if:

- your vehicle is already carrying the maximum allowed number of passengers
- a passenger is offensive or dangerous to you or others.

Good professional habits go hand in hand with good passenger relations. To passengers, reliable and expert service means getting them to where they are going safely and comfortably, by the most direct route.

## Taxi or limousine permits

Municipalities have different requirements for issuing a taxi permit. Check with your municipality about the requirements needed to obtain a taxi or limousine permit.

**NOTE:** Always check municipal laws regarding taxi operation.

## Seat belts



According to Alberta law, all drivers and passengers are required to use seat belts where the assemblies are provided. However, the driver of a taxicab is exempt from wearing a seat belt while carrying a passenger for compensation or hire.

## Reserved lanes

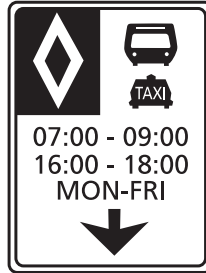

Reserved lane signs are placed over or beside lanes to indicate that these lanes are for use by specific vehicles only. The symbol on the sign shows the type of vehicles that are permitted to use the lane. The symbols that may be seen are the silhouettes of a bus, taxi, and bicycle. Reserved lanes that are designated for part time operation will show the hours of the day and the days of the week when that lane is reserved. If a lane is designated for full time use, the sign will not show the times and days. There will be a final sign at the end of the reserved lane to show that the reserved lane ends. The white diamond on a black background indicates that the vehicles in the reserved lane travel in the same direction as the traffic.

# Other uses for a Class 4 licence

## Definition of “For hire”

A Class 4 licence is required for a driver who is operating a vehicle under the condition for hire, as defined below from the *Operator Licensing and Vehicle Control Regulation*.

*For hire with respect to a vehicle, means that the vehicle owner or operator, or the operator’s employer, is being paid for the service that the vehicle is being used to provide, but for the purposes of sections 23 (Class 3 licence) and 25 (Class 5 licence), a motor vehicle is not for hire when the operator drives a private passenger vehicle for the transportation of passengers on an incidental or occasional basis and receives compensation in respect of the transportation of those passengers only in one or more of the following forms:*

- 1** *as payment for the kilometres travelled at a rate not exceeding the limit of tax-exempt allowance paid by employers to employees as prescribed in section 7306 of the Income Tax Regulations of Canada (CRC chapter 945);*
- 2** *as straight reimbursement for out-of-pocket expenses directly related to the transportation, including, without limitation, gas, parking, gate passes and tolls;*
- 3** *in a case where the operator is party to an agreement to provide transportation to only the operator’s family members, members of the operator’s household or persons for whom the operator is a legal guardian, as compensation only to provide transportation to those persons.*





# Transporting Persons with Disabilities

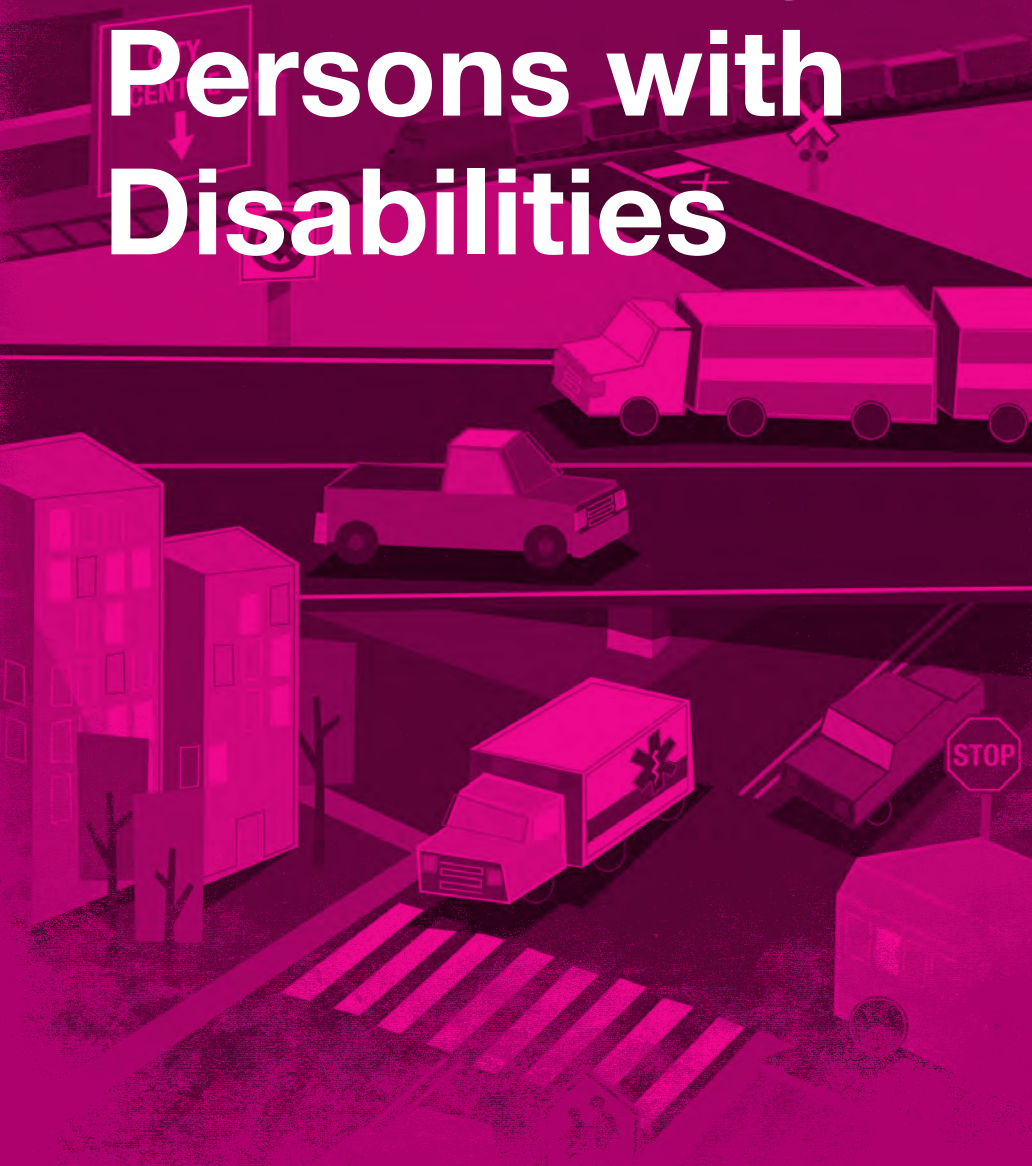



As a driver of persons with disabilities, you need to be aware of the unique needs of your passengers, who may range from young children to senior citizens. As their needs may be related to cognitive, developmental, sensory or physical disabilities, you will want to be familiar with ways you can provide the best customer service for the different disabilities. For example, frail seniors and those with reduced mobility may have health conditions that affect their balance and lead to unsteadiness or falls.

It is also important to be sensitive to your client's personal space. Drivers should recognize that some people may feel uncertain if they are in a new environment.

It is important to communicate with your passengers by responding to each person's needs. As disabilities can affect an individual in different ways at different times, never assume you know an individual's needs without first asking. Above all, be patient, courteous and understanding of your client's needs.

## General rules for communicating

- Take time to discover each person's preferred method of communicating. Whenever possible, communicate directly with the person with the disability before addressing an attendant.

- When meeting a client for the first time, it is important to review the process that will be followed to transport the individual. This way the client will be reassured and understand what is happening.
- When talking for any significant time to those using wheelchairs or mobility aids, place yourself in front of them, at their eye level.
- Offer to people who can walk assistance when it looks like it is needed, but wait until your offer is accepted before you help.
- When assisting people who are visually impaired, it is important you identify yourself. Offer to help by saying something like, "You can take my arm" or "May I help/guide you". If your help is accepted, let the person being guided take hold of your arm.
- When assisting passengers who are hearing impaired, gesture with your hand or touch their arm lightly to get their attention.

## General rules for driving

- Make sure passengers are properly secured in the vehicle (both seated and wheelchair passengers).
- Drive smoothly, avoiding sudden stops, starts and swerves that may cause passengers to shift or lose their balance. Ease around corners.
- Maintain a comfortable temperature and air circulation inside the vehicle.
- Keep the noise level in the vehicle, including music or radio, to a level comfortable for your clients.

# General rules for assisting a person with a wheelchair

- Ensure that the passenger's feet do not slip from the wheelchair foot rests.
- Push the wheelchair at a normal walking speed. Watch at least three metres (10 feet) in front of you and along the sides of the wheelchair.
- Watch for small cracks or bumps in your path and for other people and objects. Keep your pace slow. Gently tilt the wheelchair over large bumps or cracks.
- Judge distances by the front of the foot pedals rather than the front of the seat.
- Watch for loose handle grips or armrests that are not locked into place.
- Be careful not to bang the wheelchair or handle it roughly.
- Apply the wheelchair brakes when the wheelchair is stopped.

You can find more detailed information regarding transporting persons with disabilities by contacting:

[Strategic Policy Branch](#)

Edmonton 780-427-7944

For toll free service from anywhere in Alberta, call 310-0000.



9

# Transporting Dangerous Goods

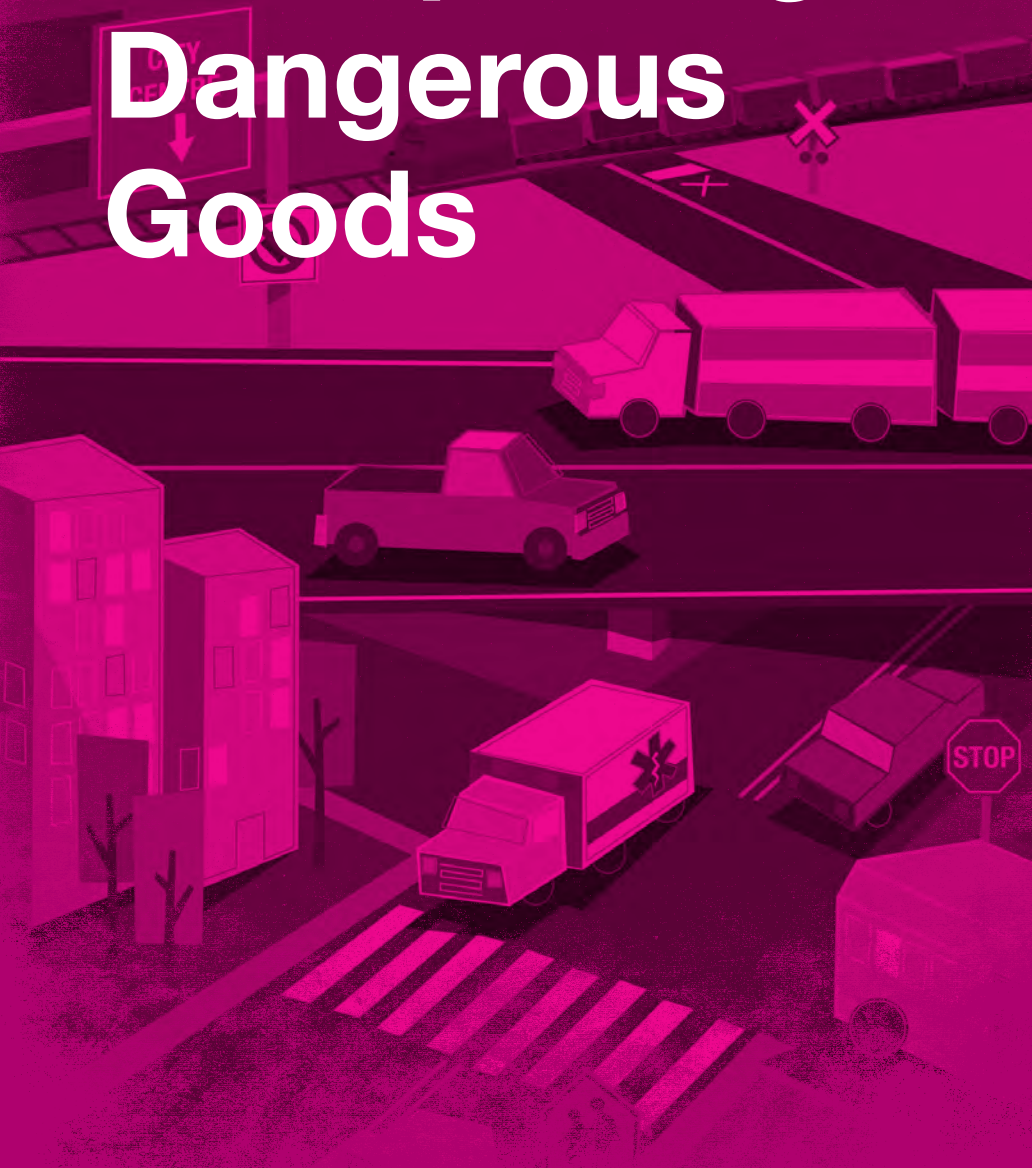



The laws on dangerous goods state that no one shall handle, offer for transport or transport dangerous goods unless they are trained or they work in direct contact with someone who is trained.

## Training Requirements

Carriers are responsible to make sure their employees have the proper training to work safely with dangerous goods. This usually means a formal in-house training program to earn a Dangerous Goods Training Certificate. This certificate shows that the employee has successfully completed the training. Carriers can provide their own training or may hire someone to do the training for them. However, in all cases, the **employer** must be satisfied with the training, and sign the certificate of training indicating that the driver has successfully completed the dangerous goods course.

A driver of dangerous goods is required by law to produce a certificate of training, if asked to by a dangerous goods inspector.

## What is a dangerous good?

There are nine hazard classes of dangerous goods. Within some classes there are divisions.

### Class 1:



#### EXPLOSIVES

- 1.1** A substance or article that explodes as a mass.
- 1.2** A substance or article with a fragment projection hazard, but not a mass explosion hazard.
- 1.3** A substance or article that has a fire hazard along with either a minor blast hazard or a minor projection hazard or both, but not a mass explosion hazard.
- 1.4** A substance or article that presents no significant hazard, with explosion effects that are largely confined to the package and no projection or fragments of appreciable size or range are to be expected.
- 1.5** A very insensitive substance that has a mass explosion hazard like those substances in 1.1.
- 1.6** An extremely insensitive substance that can have a mass explosion hazard like those substances in 1.1.

### Class 2:



#### GASES

- 2.1** A flammable compressed gas.
- 2.2** A non-flammable, non-toxic compressed gas.
- 2.3** A toxic compressed gas.

## Class 3:



### FLAMMABLE LIQUIDS

- 3** A liquid with a closed-cup flash point of less than 60.5 degrees Celsius.

## Class 4:



### FLAMMABLE SOLIDS, SUBSTANCES LIABLE TO SPONTANEOUS COMBUSTION, AND SUBSTANCES THAT EMIT FLAMMABLE GASES ON CONTACT WITH WATER

- 4.1** A solid that:
- ignites easily while it is being transported,
  - burns vigorously and persistently, or
  - contributes to fire through friction or from heat kept during manufacturing or processing.
- 4.2** A substance that might spontaneously combust when exposed to air, or might spontaneously heat up to the point where it ignites in contact with air.
- 4.3** A substance that might emit flammable gas(es) or create enough heat to ignite gas(es) if it comes in contact with water or water vapour.

## Class 5:



### OXIDIZING SUBSTANCES AND ORGANIC PEROXIDES

- 5.1** A substance that contributes to the combustion of other material by yielding oxygen or other oxidizing substances, whether or not the substance itself is combustible.
- 5.2** An organic compound that has the bivalent “O-O” structure that is a strong oxidizing agent and may be liable to explosive decomposition or is sensitive to heat, shock or friction.

## Class 6:



### TOXIC SUBSTANCES AND INFECTIOUS SUBSTANCES

- 6.1** A solid or liquid that is toxic when:
- its vapours are inhaled,
  - it comes in contact with skin
  - it is ingested.
- 6.2** Infectious organisms or organisms believed to be infectious to humans and animals.

## Class 7:



### RADIOACTIVE MATERIALS

Radioactive materials are not named, only described by activity or package requirements.

## Class 8:



### CORROSIVE MATERIALS

Corrosive materials will corrode metal, human skin and internal tissue.

## Class 9:



### MISCELLANEOUS PRODUCTS OR SUBSTANCES

- 9.1 Miscellaneous dangerous goods.
- 9.2 An environmentally hazardous substance.
- 9.3 A dangerous waste.

## Dangerous occurrences

A driver who is in charge of, in management of, or in control of dangerous goods when a dangerous incident occurs such as a leak or a collision, or an unintentional release or near release, must immediately notify:

- the local police
- Alberta Government, Co-ordination and Information Centre (CIC) at 1-800-272-9600
- the owner of the vehicle
- the employer
- the person or company who owns the consignment of dangerous goods.

## Documents

Every driver who transports dangerous goods, must have with them a copy of the shipping document, waste manifest or any other of the document(s) required by law. The document(s) must be within reach or in a pocket mounted on the driver's door when the driver is in the cab of the truck. When not in the cab, the document(s) must either be on the driver's seat or in the pocket on the driver's door.

When a parked trailer carrying dangerous goods is not attached to the tractor, the person in charge of the parking area must keep one copy of the documents. If there is no one in charge of the parking area, a copy of the documents in a waterproof container should be attached to the trailer, in a place easily seen and accessible.

When a driver is making more than one delivery of dangerous goods and transporting them by a tank truck, tank trailer or individual gas cylinders, the change in quantity of dangerous goods must be shown on the shipping document. This must be done after each delivery.

For complete information regarding the transportation of dangerous goods, please call:

[Dangerous Goods,  
Vehicle and Rail Safety Branch](#)  
Edmonton 780-422-9600

## Safety marks

Safety marks, when needed, will be supplied by the consignor. A driver who transports dangerous goods has the responsibility to make sure the vehicle has all the proper safety marks, placards, or orange panels on it **before** it is loaded. The safety marks must be placed on each side and each end of a trailer or transport unit.

Placards and panels may be moved to the front of the lead vehicle so the safety marks are visible. The safety marks must stay on the vehicle or large container until no hazard exists. This means the dangerous goods have been unloaded and the container or vehicle cleaned and purged of all residues of dangerous goods.

If the dangerous goods placards and panels are lost, damaged, or defaced during the trip, the carrier must replace them.

**NOTE:** *Every vehicle used to carry Class 1 material, Explosives, must carry a document signed by the owner or the person leasing the vehicle, indicating the name of the driver(s) authorized by them to operate or accompany the vehicle.*

For toll free service from anywhere in Alberta, call 1-800-272-9600, 24 hour service.

# NOTES

---

---

---

---

---

---

---

---

---

---

---

---

---

---

---

---

---

---

---

---

---

---

---

---

---

---

---

---

---

---

10

# Responsible Driving Tips for Commercial Drivers

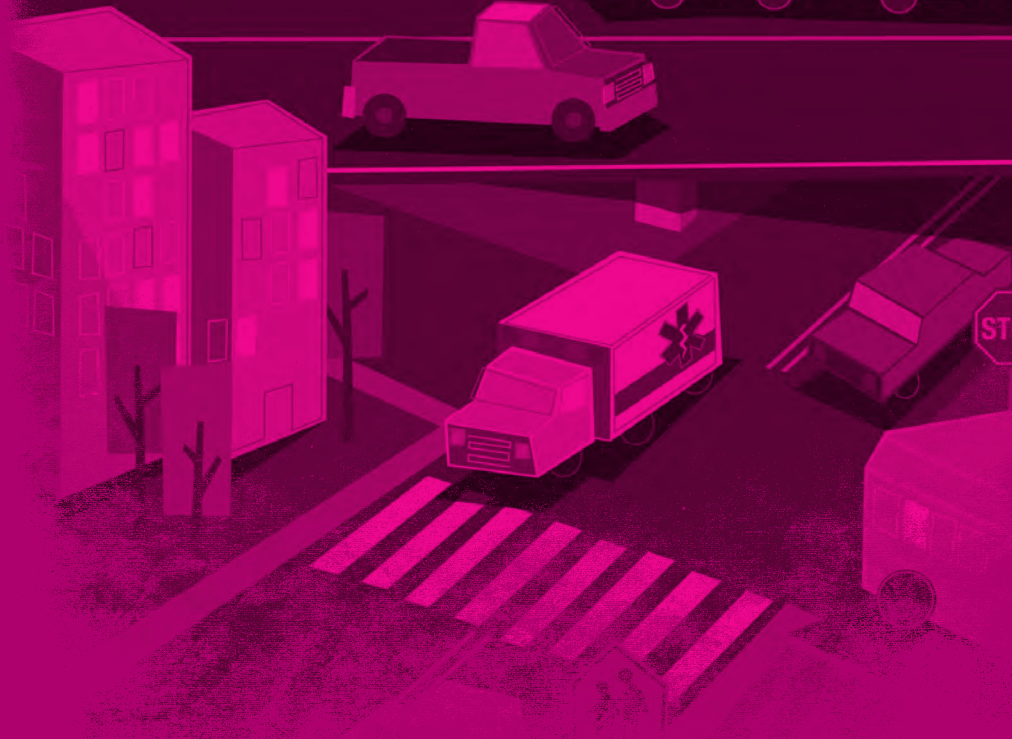

# Distracted driving law for commercial drivers

## Types of vehicles

The distracted driving law will apply to all vehicles as defined in the Traffic Safety Act. It will include vehicles like cars, motorcycles, motor homes, truck tractors, farm vehicles and bicycles.

## Cellular phones and other distractions

Do not use a cellular phone or other electronic devices while driving. Using a cellular phone to make or receive a call, or to receive or send a text message is a distraction that can take your attention away from the demanding task of driving. This applies to hands-free cellular telephones as well. If you want to make or receive a call, or receive or send a text message, stop in a safe and legal place.

Do not do activities that allow you to be distracted while driving. While all forms of distracted driving can be hazardous, the *Traffic Safety Act* includes fines for certain distractions. These include using a hand-held cell phone; texting or emailing, using electronic devices, such as laptop computers, video games, cameras, video entertainment displays and programming portable audio players; entering information on GPS units; reading printed materials in the vehicle; writing; printing or sketching; and personal grooming.

## Types of emergency vehicles that are exempt

Under the Traffic Safety Act, an emergency vehicle includes, police service vehicles, fire response units, ambulances and gas disconnection units responding to a call. Drivers of emergency vehicles will be able to use hand-held communication devices or other electronic devices only when acting within the scope of their employment.

## Activities that are allowed for commercial drivers

These activities are not specifically restricted under the law:

- using two-way radios or hand-held radios, such as those commonly referred to as CB (Citizen's Band) radios, when escorting oversized vehicles, to contact one's employer, or when participating in search, rescue and emergency management situations.

Display screens that are permitted:

- a GPS navigation system – as long as the system is affixed to the vehicle and programmed before you begin driving or the system is voice activated. You cannot hold the unit or manually enter information while driving.
- a gauge, instrument, device or system that provides information about the vehicle's systems or the vehicle's location
- a dispatch system for transporting passengers
- a logistical transportation tracking system that tracks vehicle location, driver status or the delivery of goods for commercial purposes

## Dispatch computers like those used in taxicabs or delivery trucks

Drivers who use dispatch systems for the transport of passengers or logistical transportation tracking devices for commercial purposes can still have mobile data computers installed and activated in their vehicles. All drivers should keep their focus on the road and as such, drivers should not type information into these devices while driving.

## ‘CB radios’ or ‘Mike Phones’ are exempt for commercial purposes and search and rescue services

This legislation is not intended to interfere with well-established commercial operations or search and rescue efforts. Where this type of communication is required to communicate with the driver’s employer or when participating in some type of emergency management situation the use of what are commonly referred to as hand- held CB radios or ‘Mike phones’ are allowed.

This law is not about taking away tools for traffic safety. The use of hand-held radios to communicate extreme weather conditions or a hazard on the roadway, such as a collision, could fall under the “emergency” scenario category. Alberta Transportation recognizes that commercial drivers are professionals and anticipates that they will make good safety decisions when choosing to use public radio systems. As with all laws, enforcement officers ultimately have the responsibility to evaluate specific situations to determine if citizens are complying with the law.

## Tour bus drivers

Tour bus drivers must be in compliance with the law and must not drive distracted. There are hands-free units, available to ensure compliance with the law, as well as innovative technology solutions to provide information to passengers.

## Fatigue

Driving while exhausted can make you a road hazard. Drowsy driving is as dangerous as impaired driving because it slows a driver’s reaction time, decreases awareness and can impair judgment like alcohol or drugs.

Lack of sleep is one of the most common causes of drowsy driving. Other contributing factors include driving alone, driving long distances without rest breaks and driving through the night, or at times when the driver normally sleeps. Taking medication that increases sleepiness or drinking alcohol also contributes to driver fatigue.

People most at risk for falling asleep at the wheel are shift workers, commercial drivers, people with untreated sleep disorders, teenagers and young adults. Fatigue-related crashes are common in young drivers because they tend to stay up late, sleep less than they should and drive more often at night.

## Warning signs of driver fatigue

- Yawning
- Inability to keep eyes focused and head up



# Railway Crossing

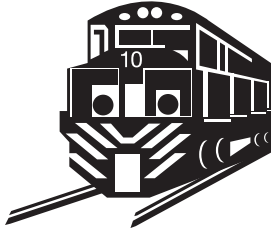

- Having wandering, disconnected thoughts
- Driving the past few kilometres without remembering them
- Drifting between lanes, tailgating or missing traffic signs
- Noticing a vehicle in the rear view mirror that seemed to appear out of nowhere

Most fatigue-related collisions happen between 1 - 4 p.m. and early in the morning between 2 - 6 a.m. Typically, fatigue-related collisions occur at higher speeds and can result in drivers running off the road or vehicles colliding head-on with other vehicles or stationary objects.

## How to reduce driver fatigue

Turning up the radio, opening a window, drinking coffee, chewing gum or eating will help reduce driver fatigue for short periods of time but the following actions will help prevent driver fatigue:

- Become aware of your own biological clock and avoid driving during your body's down time.
- Stop if you become sleepy while on the road.
- Get plenty of sleep the night before a long trip.
- Avoid working all day and then driving all night. Stay overnight rather than driving straight through.
- Schedule a break every two hours or every 160 km. Stretch or take a walk to get some fresh air.
- Take a mid-afternoon break. Have a 20-40 minute nap.
- Travel with an awake and alert passenger. Having someone to chat with will keep the driver awake and the passenger can also let the driver know if he/she is showing any signs of fatigue.

Crossing railway tracks can be especially hazardous for drivers of large vehicles because of the following:

- Longer vehicles need to travel further and will need more time to clear a crossing.
- Heavier vehicles take more time and need more room to stop before a crossing.
- Larger vehicles are more likely to derail a train if there is a collision.

## Suggested approach to stopping

- Slow down, shift to a lower gear if you have a manual transmission, and test your brakes.
- Check for traffic behind you and then stop gradually.
- Stop no closer than five metres (about 16 feet) and no further than 15 metres (about 49 feet) from the nearest rail.
- To better hear a train, roll down the window and reduce any noise inside the vehicle.
- While stopped, look carefully in each direction for approaching trains. Look around obstructions such as mirrors and windshield pillars.
- When waiting, put on your park brakes so that you will not move onto the track.

## Resume travel

- Before resuming travel, make sure there is enough room on the other side of the track for the whole unit to clear, including the vehicle's overhang. Be aware that a train will be a metre wider than the rails on both sides.
- Use a gear that will let you cross the track without shifting.
- Check the crossing signals one more time before proceeding.
- If the crossing lights begin to flash after starting, keep going. It is safer to continue than to back up.
- If there is more than one track, there may be more than one train. Do not assume the train you see is the only one.

## Other considerations

### Vehicle stalled or stuck on the tracks

If your vehicle stalls or gets stuck on a crossing, get out of the vehicle immediately. If a train is coming, move away from the track toward the oncoming train. This will reduce the chances of being struck by flying debris if the train hits the vehicle. Contact the railway company if its emergency number is posted or call 911.

### Viewing the tracks at a crossing

Do not attempt to cross the tracks unless you can see far enough in both directions to be sure that no train is approaching. Be especially careful at crossings without gates, flashing lights or bells. Even if there are active warning signals, and they do not

indicate that a train is approaching, you should still look and listen to be sure it is safe to proceed.

Be cautious when approaching an uncontrolled rural railway crossing at night. A train may be crossing in front of you. The presence of a train may appear like a black, dark object against the background of a dark road.

## Vehicle size and clearance

Know the length of your vehicle, the amount of overhang and the amount of space that is available on the other side of the railway crossing. When approaching a crossing and a STOP sign is facing you on the opposite side of the tracks, pay attention to the amount of room there is between the tracks and the sign. Be sure there is enough space to completely clear the railway tracks on the other side. If there is insufficient space and your vehicle would over hang the railway tracks you must visually and audibly ensure there is no oncoming train. Then proceed to the stop sign and stop. When safe, proceed, ensuring that your vehicle does not block the railway crossing for more than 20 seconds

## Railway crossings at rural roads

Pay extra attention when you cross railway tracks in rural areas because of the following:

- Approach grades may be steeper.
- Snow banks may be higher.
- Brush and trees may be more common.
- There tend to be fewer automated warning systems.
- The grade crossing may be rough or uneven.

# Know the law

## Controlled crossings

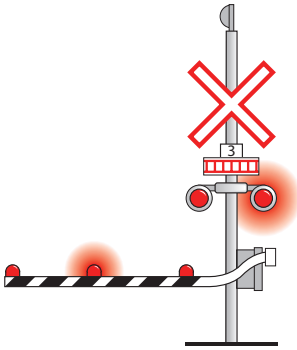

A controlled crossing is one with a flag person, stop sign, crossing gate or an electric or mechanical signalling device. All vehicles are required to stop at controlled railway crossings if signalled to do so.

## Uncontrolled crossings

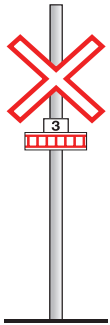

Some vehicles are required by law to stop at all uncontrolled railway crossings. These vehicles are:

- school buses
- vehicles carrying explosives as a cargo or part of their cargo
- vehicles designated for carrying flammable liquids or gas, whether the vehicle is loaded or empty.

If a police officer or a properly identified railway flag person is at the crossing, obey his or her direction as to whether or not to proceed at the crossing. Also, be aware that municipalities may have a bylaw, in addition to provincial regulations, that govern your action of whether or not to stop. This bylaw may apply at any or all railway crossings within their jurisdiction.

## Fire and fire extinguishers



A fire can start from several causes. Here are some tips to prevent fires.

- Never start a vehicle with a fuel leak. Repair the leak and use an approved absorbent material to soak up the fuel spill.
- Shut off the engine when refueling.
- Touch the fuel hose nozzle against the filler pipe of the vehicle tank before filling to ground it. This prevents sparks caused by static electricity.
- Do not smoke near the fueling areas.
- Check your tire pressure often. Soft tires build heat and can cause a fire.
- Ensure that all your vehicle's brakes are fully released when the vehicle is moving. Dragging brakes generate heat that can ignite grease in the hubs when the vehicle stops.

If you are carrying passengers on a bus and discover a fire, or danger of fire, stop immediately in a safe location. Get your passengers off the bus and to a safe spot at least 35 metres (115 feet) from the vehicle. Portable fire extinguishers are carried in the driver's compartment in most commercial vehicles.

## Fire extinguisher operation

**Do not** try to put out a fire that is beyond your capability or that of the fire extinguisher.

Remember, depending on the type and size of the extinguisher, you will have only eight to ten seconds of chemical discharge.

Although there are different kinds and makes of fire extinguishers, they are all used in the same basic way.

- Remove it from its bracket.
- Approach the fire from upwind if possible.
- Hold the extinguisher in an **upright** position.

Remember the word **PASS**.

The word **PASS** means:

Once the fire is out, do the following:

- Replace the safety pin and return the fire extinguisher to its storage compartment.
- Note on the post-trip inspection that the extinguisher has been used and have the extinguisher recharged immediately or replaced.

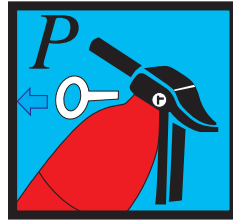

*Pull the pin and point the nozzle away from you.*

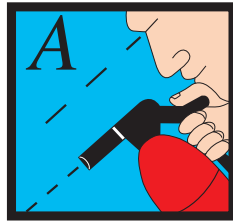

*Aim low and direct the extinguisher at the base of the fire.*

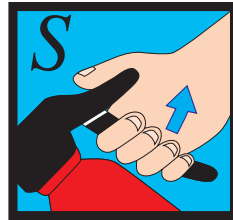

*Squeeze the handle slowly and evenly. Continue to squeeze until the fire is out and/or the fire extinguisher is empty.*

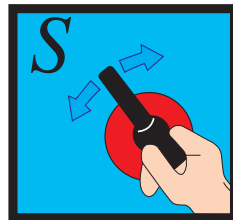

*Sweep the extinguisher from side-to-side. Start at one side of the fire and slowly work to the other side. Do not start in the middle of the fire.*

## NOTES

---

---

---

---

---

---

---

---

---

---

---

---

---

---

---

---

---

---

---

---

---

---

---

---

---

---

11

# Fueling and Fuel Efficiency

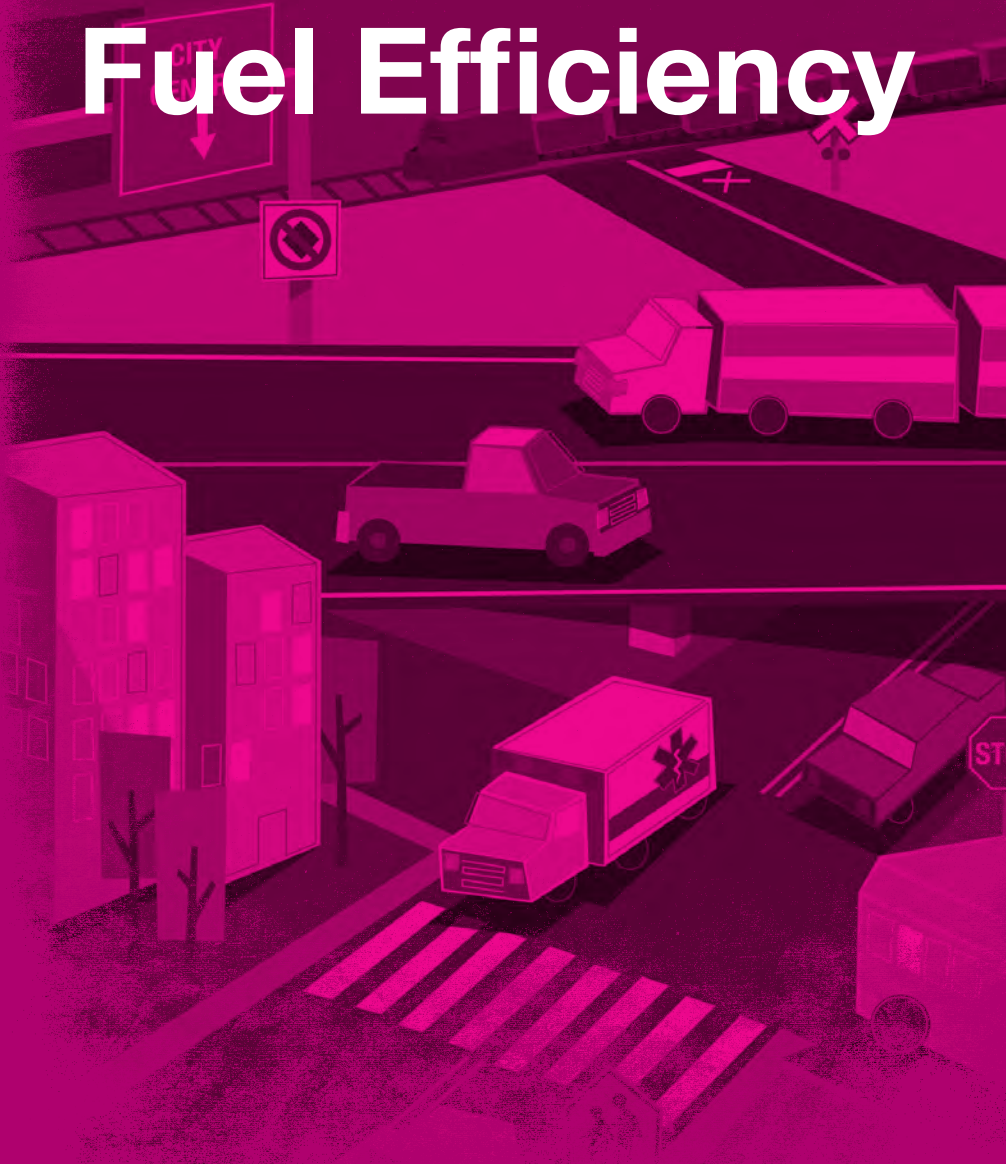

# Fueling a vehicle

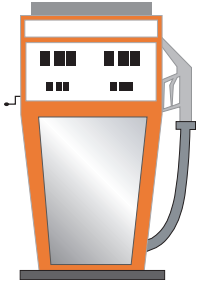

## Gasoline and diesel

- Do not add fuel into the tank when the engine is running.
- Never overfill the fuel tank.
- In the event of a major or minor fuel spill, notify the attendant to get it cleaned up immediately using an approved absorbent material.
- Do not add fuel close to electrical sparks or open flame.
- DO NOT SMOKE, and be sure no one around is smoking.
- Do not use a cell phone while fueling.

## Propane

- Only people with the proper certification or training can refuel a propane vehicle or container.
- Ensure there is nothing that could ignite within three metres (10 feet) of the dispenser or container being filled.
- Wear proper protective gloves and clothing, such as long sleeve shirts.
- Engine and electrical accessories must be switched off.
- DO NOT SMOKE, and be sure no one around is smoking.
- Do not use a cell phone while fueling.

- Properly attach the filling hose to the vehicle's fuel tank.
- Open the fixed-liquid level gauge (bleeder valve).
- When the fuel level reaches the maximum permitted in the tank, liquid propane in the form of a mist will be discharged from the liquid level gauge. Fueling should now end.
- The fixed level gauge must be shut off and the fill-line disconnected.
- The magnetic float gauge attached to the tank should indicate that the tank is now filled to capacity. The total capacity of the tank is approximately 80 percent.

Do not fuel a vehicle when the engine is running or a radio transmitter is on. Vehicles such as a bus, school bus or taxi should not be fueled when passengers are on board. Be sure there is sufficient fuel for the trip before picking up your passengers.

## Fuel efficiency: A growing priority

The following information has been provided by Natural Resources Canada in conjunction with the Government of Alberta to introduce energy-efficient practices that can reduce fuel consumption and emissions. FleetSmart is a component of this program. For more information on this subject visit this web site: <http://www.transportation.alberta.ca/4531.htm>

As fuel prices fluctuate, independent drivers and major transport companies are struggling to accurately budget for fuel costs and are actively searching for ways to keep those costs under control.

Of course, money isn't the only consideration. The environment is a key factor, too. Nearly 30% of all greenhouse gas emissions in Canada are produced by the road transportation sector, a significant portion of them from heavy-duty vehicles. Fortunately, there are many practical decisions you can make as a driver to be more fuel-efficient - from vehicle specifications to behind-the-wheel techniques and behaviours.

## Making smart choices

Your driving habits can reduce the amount of fuel you burn. Here are some tips you can take:

## Preparation and planning

- Plan your route carefully: flat routes are more fuel efficient than mountainous routes; highway driving is more fuel efficient than “inner city” driving.
- Carefully consider your vehicle specification options and always maximize your payload: instead of 60% capacity, try to achieve 80 or 90% capacity.
- Read the owner's manual for your vehicle and follow the manufacturer's driving recommendations.

## Fuel and your engine

- Using the proper grade and type of fuel can improve fuel economy by as much as 3%.
- A direct drive transmission instead of an overdrive transmission may reduce fuel consumption by up to 2%.

## Vehicle choice and accessories

- Optimize tractor aerodynamics: reducing aerodynamic drag by 10% can increase fuel efficiency by 5%. Consider using doubles or triples instead of single trailers where authorized.
- Use rib design tires in all positions: it's more fuel efficient than using lug tires on the drive and steering axle.
- Consider using low rolling resistance tires. When looking at the specifications of a new truck, remember that super single tires provide low rolling resistance as well as lower height and less weight.
- Choose lighter truck specifications where appropriate. Less vehicle weight means better fuel economy and can also offer more freight capacity increasing income per kilometer traveled.
- Use accessories such as oil pan heaters and block heaters (to help with cold starting and hasten lubrication), fuel heaters (to prevent fuel gelling), thermostatically controlled engine fans, winter fronts, battery blankets and in-cab auxiliary heaters to improve productivity and fuel efficiency.

## Dealing with the weather

Weather conditions affect fuel efficiency. Driving on snow-covered roads can increase fuel consumption by 15 to 20%, and fuel economy can be significantly affected by heavy winds. Here are a few ways to minimize the effects of weather:

- Avoid bad weather where possible by changing trip times or routes.
- Adjust speed to suit the conditions,



- e.g., reduce speed when there's a strong head wind.
- Slow down and maintain safe following conditions in order to better anticipate other vehicles in front of you.
  - Do not park your tractor-trailer on an icy grade - getting stuck wastes fuel and time.

**NOTE:** Choosing to drive a flat, multi-lane highway improves your fuel efficiency by:

- 4 to 11% compared to a flat two-lane highway;
- as much as 18% compared to a mountainous highway; and
- 25 to 35% compared to taking a suburban route.

## Caring for your vehicle

Preventative maintenance plays a huge role in maintaining the health and efficiency of your vehicle. When your truck is serviced properly, you can run more efficiently and avoid unexpected downtime. Small problems should be fixed before they become bigger - and more expensive. In addition to regularly scheduled maintenance, you should also:

- Ensure your tires are inflated according to the manufacturer's recommendations - 1% of fuel is wasted for each 10 pounds per square inch of under inflation.
- Before you hit the road, make sure you've done a pre-trip inspection - not only is it the law but it can also help you avoid unwelcome breakdowns during your travels.
- Perform a post-trip inspection to spot problems that could delay you next time.
- Ensure all fluid levels are correct. Under-

filling and over-filling can both damage your vehicle.

- Monitor your restriction indicator for signs of the air filter becoming plugged or contaminated.
- Continually monitor your vehicle's condition during your trip: check gauges, tires and cargo every three hours.

## Smart driving practices

Fuel efficiency starts when you turn your engine on. Proper warm-up helps lubricate components and seals reducing wear and leakage. Starting your truck properly can save money on fuel. Keep the following in mind:

- When starting your vehicle make sure you use zero throttle and are in a gear that does not need any throttle.
- Do not pump the throttle of a fuel-injected engine: the amount of fuel required for starting is pre-measured. Similarly, do not pump the throttle when cranking with older mechanical engines: it wastes fuel and can damage cylinder walls.
- Use ether sparingly when having difficulty starting your engine: excessive use can harm the engine.
- When warming up the engine do not increase the engine speed. Five minutes of idling for a warm-up is generally adequate, and cool down is provided when pulling-in for parking.
- Ensure oil and air pressure are in their normal operating ranges during start up.
- Warm your vehicle up after the initial idle time by driving easily; do not try to get too much speed out of the engine by pushing the throttle down hard.

- Back off the accelerator when going over the top of a hill and let gravity and momentum do the work.
- Use cruise control where appropriate.
- Reduce your average speed - driving fast eats up fuel no matter what you drive.
- Change gears smoothly - shifting professionally will result in about 30% improvement in operating costs.
- Always use the clutch, failure to do so can wear the gear teeth down in the transmission.
- Practice progressive gear shifting at approximately 1600 rpm. Shifting before you reach the maximum governed rpm reduces equipment wear, decreases noise levels and saves fuel.
- Run the engine in the highest gear range to keep it in a low rev range.
- Use your retarder properly and turn it off when you do not need it - let the terrain work for you.

## Idling

Idling a truck engine burns up to four litres of fuel per hour at 900 rpm. Turn off your engine when you stop for any length of time - you will save fuel, reduce maintenance requirements, prolong engine life and prevent unnecessary emissions. If a 10-truck fleet were to cut idling by an hour a day for 260 days, it would save approximately 10,400 litres of fuel (\$11,440 at \$1.10 per litre). A 100-truck fleet would save \$114,400 and a 500-truck fleet \$572,000.

## Taking advantage of technology

New engine designs offer great benefits, delivering more horsepower and torque in lower rpm ranges. You can downshift at about 1200 rpm and up-shift at about 1600 rpm - rather than 2000 rpm. You shift less, save money, and generate fewer emissions.

## Keeping up with road conditions

Smart, fuel-efficient driving is also safe driving. Different road and traffic conditions present different challenges. As a driver, it's important for you to keep the following in mind:

- Light: Adjust your driving based on visibility. Wear sunglasses in bright conditions and reduce speed in poor light conditions.
- Posture: Keep your seat adjusted to the correct position for comfort, alertness, visibility and access to controls.
- Traffic: Try to travel at the same speed as other traffic, staying within the speed limit. Be considerate and give way to other drivers.

## Street smart

Managing your road speed with smart driving techniques allows you to keep your speed more constant and increase fuel efficiency. Generally, for every 10 km/h over 90km/h you use 10% more fuel.

# Driving defensively

Smart driving is both an attitude and a skill. A sharp mind and shrewd decision making can go a long way toward protecting your safety and the safety of others - not to mention increasing fuel efficiency.

Defensive driving allows you to anticipate hazards and maintain a constant speed. When you drive defensively, you conserve your momentum - which means you do not have to continually build up lost speed. Power not used is fuel not burned. Here are some helpful tactics:

- Do not let frustration push you into making unsafe passes or other maneuvers.
- Look ahead and anticipate stops. It's more efficient to coast to a stop than to brake.
- Maintain a safe following distance of four seconds.
- Be aware of your blind spots and check them regularly.
- Be aware of your own physical and mental condition including the effects of alcohol and drugs, age, attitude, illness, fatigue, emotion and diet.

## Safe stopping

Keep a safe following distance so you can always brake safely and efficiently. Driving at 70km/h requires a stopping distance of about 300 feet (90 meters).



NOTES

---

---

---

---

---

---

---

---

---

---

---

---

---

---

---

---

---

---

---

---

---

---

---

---

---

April 2014

[www.saferoads.com](http://www.saferoads.com)

*Alberta*  Government